

Pasternack

RF Product Guide 2019

Educational Products

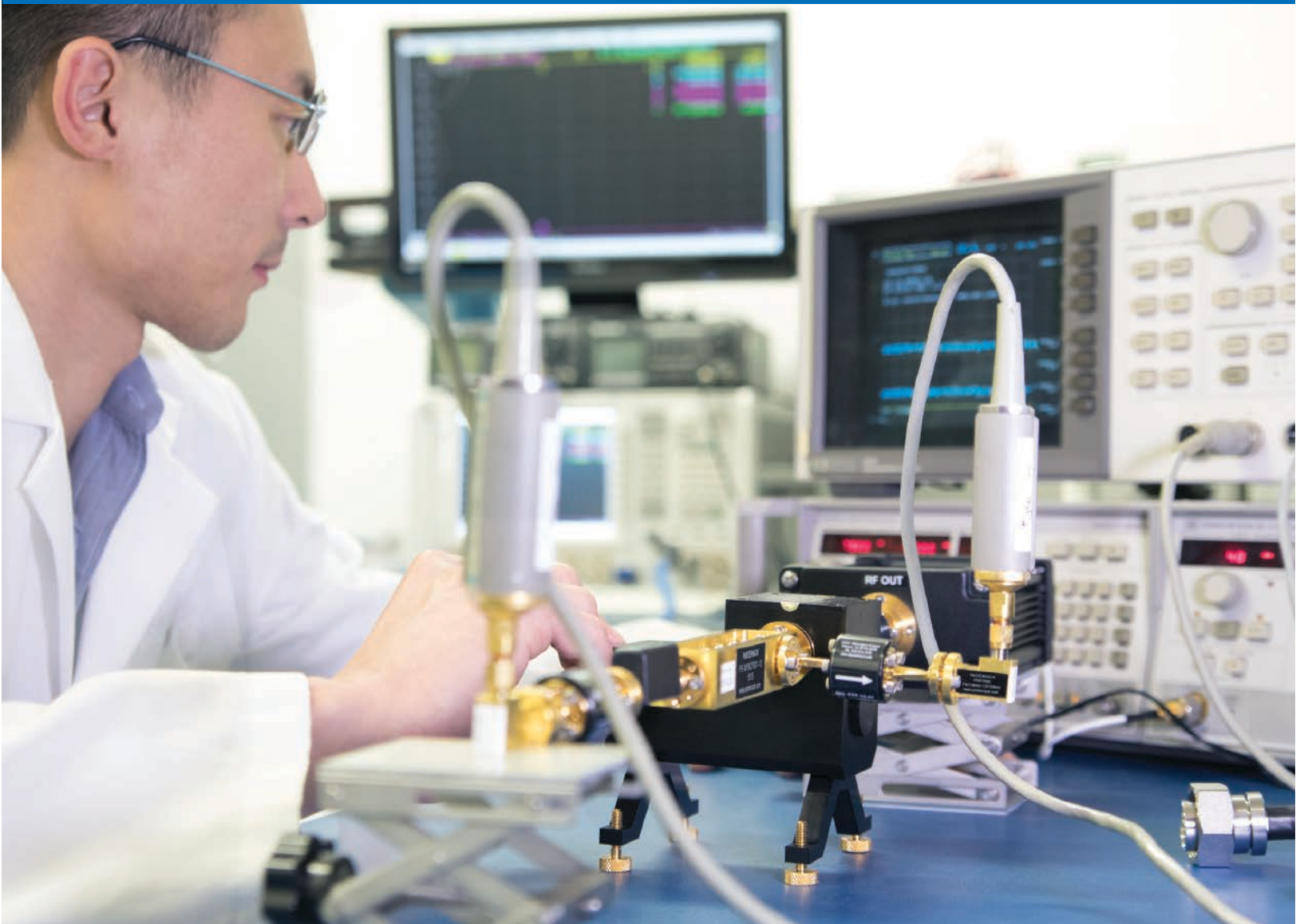

Largest Selection ✓ Same-Day Shipping ✓ Expert Technical Support ✓

866.727.8376 | sales@pasternack.com

PE PASTERNAK®
THE ENGINEER'S RF SOURCE

EDUCATIONAL PRODUCTS

60 GHz Development System



The Pasternack 60 GHz development system provides rapid evaluation of Pasternack's 60 GHz waveguide modules for quick prototyping for millimeter wave wireless system development. This high speed wireless 60 GHz developer kit is created in a partnership between Pasternack and Vubiq (pronounced "View-bik"), an industry expert in designing 60 GHz RF systems. Our 60 GHz wireless development system makes it easy and fast to design new products and applications in the emerging unlicensed millimeter wave ISM V band.

This 60 GHz wireless communications development system facilitates an accelerated design of new high bandwidth products and solutions. This Pasternack 60 GHz development kit utilizes a convenient to use GUI for configuration via USB. A standard WR-15 V-band waveguide antenna interface is incorporated into this millimeter wave system and has a 1.8 GHz modulation bandwidth. 802.11ad and 802.11aj WiFi / WiGig development is supported by the 60 GHz wireless communication system.

60 GHz Development System and Waveguide Modules is a versatile toolkit that allows imagining and designing applications in the readily accessible ISM band. The below list illustrates possible usages of the system and modules:

- High bandwidth data links, supporting multi-gigabit data rates such as gigabit Ethernet data communication
- Wi-Fi, 802.11ad and 802.11aj
- High speed video and audio solutions
- High bandwidth modulation techniques using Quadrature Amplitude Modulation (QAM) and Multiple Input Multiple Output (MIMO)
- High-Definition Serial Digital Interface (HD-SDI) video links
- High resolution radar using Frequency Modulated Continuous Wave (FMCW) modulation
- Building-to-building high speed networks
- High resolution synthetic aperture radar (also using FMCW modulation)
- Remote sensing
- Atmospheric radiometers (receive only) for oxygen and atmospheric research
- Liquid level detection
- Military applications



60 GHz Modules



The 60 GHz transmitter and 60 GHz receiver modules open up ultra high speed, high bandwidth data transmission for widespread use. Pasternack 60 GHz waveguide modules utilizes the globally unlicensed millimeter wave spectrum of 57 GHz to 64 GHz. Our wireless 60 GHz waveguide transmitter and receiver components are ideal for meeting the high speed data transmission needs of companies and developers.

These silicon germanium (SiGe) chip based 60 GHz transceiver modules are lower cost and easier to integrate than existing competing products. Pasternack's 60 GHz V band wireless solution is equally effective at a fraction of the cost and can be connected to any off-the-shelf WR-15 waveguide through the UG-385/U flange. Lower cost, ease of use and ability to attach standard components make these 60 GHz Tx and Rx units practical for a wide range of configurations and budgets.

For typical 60 GHz waveguide module applications please refer to the 60 GHz-Development Section above.

Type	Frequency Range (GHz)	Mod. Bw. (GHz)	Gain (dB)	Gain Range (dB)	Input P1dB (dBm)	Psat (dBm)	NF (dB)	Input IP3 (dBm)	ECCN	Model No	1 Pc. Price	See Web for Volume Pricing	ROW
Development System	57.0 - 64.8	1.10	both	both	both	15	6	-27	3A001.B.4.F.1	PEM009-KIT	\$12,383.24	See Web for Volume Pricing	1
Transmitter	57.0 - 64.8	1.8	38	20	12	15			3A001.B.4.F.1	PEM010	\$2,413.09		2
Receiver	57.0 - 64.8	1.8	67	65	-36		6	-27	3A001.B.4.F.1	PEM002-MIM	\$2,582.01		3
Transmitter Dev. System	57.0 - 64.8	1.1	38	20	12	15			3A001.B.4.F.1	PEM009-KIT-TX	\$8,039.26		4

See Our Website For Current Pricing & Real-Time Stock Availability!



Free Shipping Available via UPS Ground to USA & Canada



Technical Support (866) 727-8376



Same-Day Shipping, Even Custom Cable Assemblies

Gain Horn Antennas

Pasternack's high gain WR-15 horn antennas operate between 50 GHz and 70 GHz and are available in 20 dBi, 24 dBi, 34 dBi and 42 dBi gain models. Pasternack's WR-15 waveguide horn antennas pair seamlessly with the recently added 60 GHz transmit/receive development system (PEM003-KIT) which enables companies to experiment and develop applications in the globally-unlicensed 60 GHz frequency band. Using two of Pasternack's WR-15 beam antennas rated to 42 dBi gain (PE9881-42), a user is able to transmit and receive a 60 GHz signal at a distance of one kilometer (km), making these antennas an ideal solution for high frequency point-to-point backhaul.

Additionally, Pasternack offers an omni-directional millimeter wave antenna (PE-W15A001), a vertically polarized WR-15 waveguide connected antenna using a standard UG387/U flange that operates between 58 GHz and 63 GHz. This omni-directional millimeter wave antenna has a 30 degree vertical beam width and a 360 degree horizontal gain variation, making it ideal for short range wireless communications, indoor networks, high frequency applications and 60 GHz development systems. The millimeter wave omni-directional antenna is constructed with a durable brass waveguide input and light-weight aluminum body.



Freq. Range (MHz.)	Waveguide Size	Interface Type	Gain	ECCN	Model No	1-24	25-49	50-99	100+	ROW
50 - 75	WR-15	UG-385/U	20	5A991	PE9881-20	\$1,063.06	\$988.65	\$914.23	\$850.45	5
			24	5A991	PE9881-24	\$1,294.23	\$1,203.63	\$1,113.04	\$1,035.38	6
			42	5A991	PE9881-42	\$2,177.41	\$2,024.99	\$1,872.57	\$1,741.93	7
56 - 66	WR-15	UG-385/U	34	5A991	PE9881-34	\$1,494.64	\$1,390.02	\$1,285.39	\$1,195.71	8
58 - 63	WR-15	UG-387/U	0	5A991	PE-W15A001	\$3,917.71	\$3,643.47	\$3,369.23	\$3,134.17	9

60 GHz Accessories



Model No	Description	1-4	5+	ROW
PEM004	60GHz Baseboard I/Q Module	\$2,099.05	\$1,973.11	10
PEM005	60 GHz Waveguide Module Flex Circuit Cable	\$627.16	\$595.80	11

Radar Development Kits



Model No	Description	1	2-4	5-9	10+	ROW
PEM11002-KIT	2.4 GHz to 2.5 GHz ISM Band Radar Demonstration Kit, USB or Bluetooth Control, GUI, Includes Radar Board, Antennas, Cables, and Accessories	\$2,723.06	\$2,559.68	\$2,423.52	\$2,314.60	12
PEM11000-KIT	2.4 GHz to 2.5 GHz ISM Band Radar Demonstration Kit, USB or Bluetooth Control, GUI, Includes Radar Board, Antennas and Cables	\$2,500.77	\$2,350.72	\$2,225.69	\$2,125.65	13

See Our Website For Current Pricing & Real-Time Stock Availability!

PASTERNAK ENTERPRISES -- REACH PRODUCT COMPLIANCE PROGRAM

What is REACH Compliance?

Regulation (EC) No. 1907/2006 of the European Parliament and of the Council of 18 December 2006 is commonly referred to as REACH (Registration, Evaluation, Authorization, and Restriction of Chemicals). The REACH regulation became effective on June 1, 2007 to streamline and improve the former legislative framework for chemicals available in the European Union (EU) and European Economic Area (EEA) countries.

The objective of REACH is to improve protection of human health and the protection of the environment from the exposure to chemicals. REACH compliance is mandatory for products manufactured in, or imported into the European Union (EU).

As outlined by the REACH regulation, any organization manufacturing, importing, using or placing a substance, mixture, article or product on the EU market will be responsible for ensuring that the component substances are in compliance with REACH regulations.

Determining REACH Compliance of Pasternack Products:

Pasternack Enterprises does not currently either manufacture or import any chemical substances into the EU on their own or in articles (products) in quantities of 1 ton or more per year. In addition, products imported by Pasternack Enterprises' customers do not contain chemical substances intended to be released during the normal and reasonably foreseeable conditions of the product's use as defined by the REACH regulation and existing guidance.

However, under REACH, there is an obligation to ensure that articles do not contain <0.1% by weight of Substances of Very High Concern (SVHCs). SVHCs are substances that may cause cancer or other serious health or environmental effects and thus face restriction or outright bans, and are listed in a regularly-updated 'Candidate list'. The current Candidate list can be downloaded from the European Chemicals Agency (ECHA) website:

http://echa.europa.eu/chem_data/authorisation_process/candidate_list_table_en.asp

For each part that has been found to comply with the REACH SVHC reporting requirements, we show an indication of compliance adjacent to the part number using this symbol:



All products displaying this symbol on our website are assured to contain no SVHCs as defined by the Candidate List displayed on the Pasternack REACH certificate. When you locate the product you need on our website, please click on the "Product ID or Part Number". You will see the "REACH symbol" for the specific part. Click on this symbol to view the Certificate of REACH Compliance (printable if needed) for the specific product as well as the applicable ECHA SVHC Candidate list Date.

Pasternack Enterprises - REACH Product Compliance Program:

At Pasternack Enterprises, we recognize our responsibility as a worldwide supplier of RF, Microwave and Fiber Optic Products subject to the REACH regulations. We have completed a comprehensive effort internally and with our supply chain to determine the REACH compliance of our products. You will find our Reach Symbol adjacent to all products on our website that have been determined by Pasternack and our supply chain to contain less than 0.1% by weight of the REACH substances. You will also see the applicable ECHA SVHC Candidate List Date. "Please refer to our website at www.Pasternack.com.

The Pasternack Enterprises REACH Product Compliance Program is implemented in accordance with Regulation No. 1907/2006 of the European Parliament and the Council of 18 December 2006. Pasternack has implemented a REACH compliance program to address this legislation. Pasternack Enterprises does not currently either manufacture or import any chemical substances into the EU on their own or in articles (products) in quantities of 1 ton or more per year. In addition, products imported by Pasternack Enterprises' customers do not contain chemical substances intended to be released during the normal and reasonably foreseeable conditions of the product's use as defined by the REACH regulation and existing guidance. Thus, Pasternack Enterprises does not currently have a direct REACH obligation to pre-register substances. Pasternack's REACH Product Compliance is determined by a certification from our supply chain. A Pasternack product is deemed to be REACH compliant when it does not contain Substances of Very High Concern (SVHCs) beyond the specified concentration limits of less than 0.1% by weight as outlined in REACH 1907/2006/EU regulation.

Need More Information?

If you have questions regarding REACH Product Certification on Pasternack's products, please contact the Pasternack REACH Compliance Team via email at REACH@Pasternack.com or by calling Toll-Free within North America at 1-866-PASTERNAK (1-866-727-8376). International customers, please call +1-949-261-1920.



Free Shipping Available
via UPS Ground
to USA & Canada



Technical
Support
(866) 727-8376



Same-Day Shipping,
Even Custom
Cable Assemblies

PASTERNAK ENTERPRISES ROHS COMPLIANCE PROGRAM

Lead-free solder is now available for all cable assemblies upon request or online at www.Pasternack.com.

Our Commitment

At Pasternack, we recognize our responsibility as an international supplier of RF, Microwave and Millimeter wave electronics products to maintain a comprehensive RoHS compliance program. We are fully committed to offering RoHS compliance on the majority of our products and posting accurate RoHS compliance status for all of our products. We have posted this data on our website so that it can be easily found for each part number within our on-line catalogue.

What is RoHS Compliance?

The European Union set forth the RoHS (Restriction of Hazardous Substances) Directive to establish environmental guidelines and legislation to reduce the presence of six (6) materials deemed hazardous to the environment. To comply, products entering the EU must not have a homogeneous presence of these materials above the following levels by weight percentage

- Lead (Pb) < 0.1%
- Mercury (Hg) < 0.1%
- Cadmium (Cd) < 0.01%
- Hexavalent Chromium (CrVI) < 0.1%
- Polybrominated Biphenyls (PBB) < 0.1%
- Polybrominated Diphenyl Esters (PBDE) < 0.1%

Determining Pasternack RoHS Compliance

All products displaying this symbol on our website have been certified as RoHS Compliant. Click on the symbol to view the Certificate of RoHS Compliance for that product.



Lead Free Cable Assemblies

Many of Pasternack's cable assemblies are built with leaded solder. If so, the part will not be RoHS compliant and a certificate will not be found on the product page for that assembly. However, many of these assemblies can be brought into RoHS compliance through the use of Lead-Free solder. If the assembly you desire is not RoHS compliant, there may be a RoHS compliant version with a similar part number. If so, you will see an "LF" contained in the basic part number (example PE3067LF-24 is the lead free version of PE3067-24). Please note: the "LF" designation is used only when the base part number is not RoHS compliant. Many assemblies do not include "LF" and are compliant because they are only offered in a RoHS compliant configuration.

For More Information

Please direct any questions to Pasternack Enterprises Technical Support via email at TechSupport@Pasternack.com or by calling Toll-Free within North America at 1-866-PASTERNAK (866-727-8376). International customers, please use +1-949-261-1920.

MAILING LIST CHANGES

If you receive more than one RF Product Guide with the same name and address, please notify Pasternack and pass the RF Product Guide along to a friend. Also, if you do not require multiple copies to the same company address, contact a sales representative to verify and modify your mailing information. A forms-based communications method to add, delete or modify mailing information is available at www.pasternack.com. By clicking "Contact Us", and then clicking "Remove Name from Mailing List", you may complete the form to request a change to your mailing preferences. In addition, by clicking "RF Product Guide", and then clicking "Request a Printed RF Product Guide", you may add your contact information to our mailing list. Please note service opt-in and opt-out options located on the forms. Alternatively, you may mail, email, telephone or fax Pasternack your request.

PLACING YOUR ORDER

► **By Telephone: 866-PASTERNAK (866-727-8376)
US & Canada, or 949-261-1920**

Our friendly sales representatives are ready to serve you from 5:00am to 5:30pm Pacific Standard Time (PST), Monday through Friday. For the most efficient service, please have ready a list of quantities and part numbers and, if paying by credit card, your MasterCard, VISA, American Express or Discover card. Note: Calls may be recorded or monitored for quality and training purposes.

► **By Fax: 949-261-7451**

Our fax lines can be accessed 7 days a week, 24 hours a day. Orders received after 4:00pm PST will be promptly processed and shipped the next business day. Please include your daytime phone number and/or email address in case we have any questions about your order.

► **By Internet: www.Pasternack.com
or Email: sales@pasternack.com**

Order online 7 days a week, 24 hours a day using our online ordering system. Just search for the items you want and add them to your shopping cart. Internet orders entered after 4:00 pm PST will be promptly processed and shipped the next business day.

► **By Mail: Simply Mail Your Order To:
Pasternack Enterprises, Inc.
17802 Fitch
PO Box 16759
Irvine, CA 92623-6759 USA**

International customers, please see "International Orders" below for additional information.

Terms and Conditions of Sale:

The following from Pasternack's Binding Terms and Conditions of Sale are provided for your convenience. A complete documentation of the Binding Terms and Conditions of Sale may be found in the back of the RF Product Guide, or on Pasternack's website at <http://www.pasternack.com/t-terms-of-sale.aspx>. Any questions or clarifications may be answered by contacting Customer Service at (+1) 949-261-1920 or by any of the methods listed above.

No Minimum Order Requirement

Ground Freight is Free:

On UPS Ground orders, there is no charge for shipping for USA & Canada orders of \$100.00 or greater. Otherwise, shipping or freight charges and insurance will be paid by the customer. All sales are made FOB Point (as defined by the INCOTERMS 2000) in Irvine, CA USA. Shipping or freight charges from Pasternack's Irvine, CA factory are prepaid and added to the invoice or billed collect.

Same-Day Shipment:

Same-day shipment will apply to orders received Monday through Friday, prior to 4:00pm PST.

- All UPS air and surface options
- All FedEx air options (with an approved account number)
- Most other shipping options, including DHL (with an approved account number) and USPS

Counter-to-Counter Shipping:

For your urgent order requiring our fastest shipping method, we will place your order on the next available flight from Santa Ana-Orange County John Wayne International Airport (Airport code: SNA) to the destination you specify. Please call for details.

Payment Terms:

Pasternack offers a number of convenient payment methods:

For United States customers, we offer check, money order, MasterCard, VISA, American Express, Discover, and C.O.D. as well as open account credit to qualified institutions and businesses. Payment must be made in US Dollars.

For Canadian customers, we offer all of the above payment options except C.O.D.
For International customers, see **International Orders**.

Open Account Credit:

Net 30 Days terms are available to businesses, schools and agencies subject to credit approval. Approval can begin by submitting a completed Credit Application, which can be found online at:

www.Pasternack.com/t-CreditApplication.aspx

EFT/Wire Transfers:

Please contact us for details. We will inform you of the total amount which will include shipping charges and any applicable wire transfer fees. Orders will not be accepted until funds have been received in full.

WELLS FARGO BANK
420 Montgomery St.
San Francisco, CA 94104 USA
Account Number: 4270 0000 0000 0000 1
Routing Number: 121000248
SWIFT Number: WFBUS6S

International Orders:

In addition to the United States and its territories, Pasternack accepts international orders. All orders of international origin are exported from the US in accordance with the Export Administration Regulations. Diversion contrary to US Law is prohibited. Please see Pasternack's Binding Terms and Conditions of Sale for full details.

Pasternack has international distributors for the following countries:

Africa: Namibia, South Africa

Asia-Pacific: Australia, China PRC, India, Indonesia, Japan, Malaysia, New Zealand, Singapore, South Korea, Thailand

Europe: Austria, Belgium, Czech Republic, Denmark, Finland, France, Germany, Ireland, Italy, Kazakhstan, Luxembourg, Netherlands, Norway, Poland, Portugal, Russia, Slovakia, Spain, Sweden, Switzerland, Turkey, United Kingdom

Middle East: Israel

South America: Brazil

To access their complete contact information, please see our International Distributors section in this RF Product Guide. (inside back cover)

International Shipping Charges:

Shipping or freight charges and insurance will be paid by the customer. All sales are made FOB Point (as defined by the INCOTERMS 2000) in Irvine, CA USA. We ship orders by UPS, FedEx (with an approved account number), or DHL (with approved account number) with delivery in 2 to 3 days to most locations worldwide.

International Taxes and Duties:

Customer is responsible for duties and taxes.



Free Shipping Available
via UPS Ground
to USA & Canada



Technical
Support
(866) 727-8376



Same-Day Shipping,
Even Custom
Cable Assemblies

BINDING TERMS AND CONDITIONS OF SALE

The following are the terms and conditions ("Terms and Conditions") for the sale of products ("Products") by Pasternack Enterprises, Inc. ("Pasternack") to Pasternack's customers ("Customers"). Please read this agreement carefully. Any different or additional terms set forth in customer's purchase order or similar communication are objected to and shall not be binding on the company unless a separate agreement has been signed by an authorized officer of the company. By placing an order for products from the company, or by accepting delivery of the products described on the applicable packing slip, bill of lading and/or invoice received with the products, you agree to be bound by and accept these terms and conditions of sale.

1. ACCEPTANCE AND CANCELLATION OF ORDERS

All orders are subject to acceptance by Pasternack in writing by a duly authorized agent of Pasternack; any written acknowledgement of receipt of an order shall not, in and of itself, constitute such acceptance. Orders accepted and processed by Pasternack may not be cancelled by Customer except as covered by the Limited Warranty. All sales are final. Cable Assemblies and Non-Standard Products are also Non-Cancelable/Non-Refundable ("NC/NR"). Non-Standard Parts are defined as Products which are special orders, custom orders, orders for non-standard products, products not customarily in stock or orders for value-added products. In the event of cancellation or other withdrawal of an order for any reason and without limiting any other remedy which Pasternack may have as a result of such cancellation or other withdrawal, reasonable cancellation or restocking charges, which shall include all expenses then incurred and commitments made by Pasternack, shall be paid by Customer to Pasternack. Customer requests to reschedule are subject to acceptance by Pasternack in its sole discretion. Orders may not be rescheduled after the order has been submitted by Pasternack to the shipment carrier.

2. PRICES

Orders are billed at the prices (in US dollars) in effect at the time of shipment. Prices will be as specified by Pasternack and will be applicable for the period specified in Pasternack's quote. If no period is specified, quoted prices will be applicable for thirty (30) days. The website contains the most current pricing and is the price reference for orders. Pricing included in the catalog is for reference only and final pricing is determined by the published website price. Prices shown in the RF Product Guide (Catalog) and on the website are subject to change without notice. Prices are exclusive of taxes, impositions and other charges, including: sales, use, excise, value added and similar taxes or charges imposed by any government authority, international shipping charges, forwarding agent's and broker's fees, bank fees, consular fees, document fees and import duties.

3. TERMS OF PAYMENT

All payments must be in US Dollars, or will be converted to US Dollars using the available exchange rate at the time of purchase.

MasterCard, VISA, Discover, and American Express credit cards, purchase cards and major bank debit cards are accepted. Payment via net thirty (30) days is available to businesses, schools and agencies or as otherwise specified by Pasternack subject to credit approval.

For International Orders

MasterCard, VISA, and American Express credit cards are accepted. Payment via open credit account with Net thirty (30) days may be established for companies having three U.S. references accepted to Pasternack. Prepaid Wire Transfer: You can wire the funds to our bank. We will contact you with the total amount, which will include shipping charges and a \$40 wire transfer fee. Orders will not be accepted until funds have been received in full and the Purchase Order (PO) has been received. Customer is responsible for sales, use, excise, value added and similar taxes or charges imposed by any government authority, international shipping charges, forwarding agent's and broker's fees, bank fees, consular fees, document fees and import duties.

4. SALES TAX

California residents are required to remit sales tax. Pasternack does not remit sales tax to states other than California. Any sales tax due that is not collected by Pasternack is the responsibility of the customer.

5. TOLERANCES

All coaxial cable assemblies displayed in the Pasternack catalog and website have a standard cable length tolerance of $\pm 1.5\%$ or 3/8 inches (0.375"), whichever is greater. Cable Assemblies in excess of this tolerance factor are eligible for repair and/or replacement under the terms of the Pasternack Limited Warranty.

6. DELIVERY AND TITLE

Shipping or freight charges and insurance will be paid by the customer. All sales are made FCA Shipping Point (as defined by the INCOTERMS 2000) in Irvine, CA USA. Shipping or freight charges from Pasternack's Irvine, CA facility are prepaid and added to the invoice, or billed collect. Subject to Pasternack's right of stoppage in transit, delivery of the Products to the carrier will constitute delivery to Customer and title and risk of loss will pass to Customer. Pasternack will make reasonable efforts to initiate shipment and schedule delivery as close as possible to Customer's requested delivery date(s). Customer acknowledges that delivery dates provided by Pasternack are estimates only and that Pasternack will not be liable for failure to deliver on such dates. Selection of the carrier and delivery route will be made by Pasternack unless specifically designated by Customer. Pasternack reserves the right to make deliveries in installments. Delay in delivery of one installment will not entitle Customer to cancel any other installment(s). Delivery of any installment of Products within thirty (30) days after the date requested will constitute a

timely delivery. Delivery of a quantity that varies from the quantity specified shall not relieve Customer of the obligation to accept delivery and pay for the Products delivered.

7. PASTERNAK'S LIMITED WARRANTY

All products are covered by a LIMITED WARRANTY for a period of one (1) year from the date of shipment when purchased from Pasternack Enterprises, Inc. Customer must notify Pasternack within one (1) year from date of shipment of any defective product. An approved Return Material Authorization (RMA) number must first be obtained from Pasternack prior to the return of any merchandise to Pasternack for inspection under warranty. Shipping charges for all materials returned under this Limited Warranty are to be prepaid by the Customer. This warranty is limited to the original purchaser. Pasternack's liability arising out of any sale of products to Customer is expressly limited to either (1) Credit for the purchase price paid by Customer for such products (without interest), or (2) Repair and/or replacement of such products, found to be defective after inspection by Pasternack, and such remedies shall be exclusive and in lieu of all others. THIS WARRANTY IS IN LIEU OF ANY AND ALL OTHER WARRANTIES, WHETHER ORAL, WRITTEN, EXPRESSED, IMPLIED OR STATUTORY. ANY IMPLIED WARRANTIES OF MERCHANTABILITY, FITNESS FOR A PARTICULAR PURPOSE AND NON-INFRINGEMENT ARE HEREBY DISCLAIMED. Further, no warranty will apply if the Product has been subject to misuse, neglect, accident or modification, or has been soldered or altered in any way.

All returns must be shipped to: Pasternack Enterprises, Inc.
17802 Fitch
Irvine, CA 92614 USA

8. LIMITATION OF LIABILITIES

In no event shall Pasternack be liable for any special, incidental or consequential damages of any nature including, but not limited to, damages resulting from loss of profit or revenue, recall costs, claims for service interruptions or failure to supply downtime, testing, installations or removal costs, costs of substitute products, property damage, personal injury, death or legal expenses. Customer's recovery from Pasternack for any claim shall not exceed the purchase price paid by Customer for the goods, irrespective of the nature of the claim, whether in warrant, contract or otherwise. CUSTOMER SHALL INDEMNIFY, DEFEND AND HOLD PASTERNAK HARMLESS FROM ANY CLAIMS brought by any party regarding products supplied by Pasternack and incorporated into the customer's product.

9. STATEMENTS AND ADVICE

If statements or advice, technical or otherwise, are offered or given to Customer, such statements or advice will be deemed to be given as an accommodation to Customer and without charge and Pasternack shall have no responsibility or liability for the content or use of such statements or advice.

10. EXPORT CONTROL AND EMBARGOES

Products purchased or received under these Terms and Conditions are subject to export control and economic sanctions laws, restrictions, regulations and orders of the United States. Customer agrees to comply with all applicable export control laws, restrictions and regulations of the United States and shall not export, or transfer for the purpose of re-export, any product to any embargoed country or region, including but not limited to Cuba, the Crimean Region of Ukraine, Iran, North Korea, Sudan, and Syria, or to any denied, blocked, or designated person or entity as mentioned in any such United States or foreign law or regulation. Customer represents and warrants that it is not on the Denied Persons, Specially Designated Nationals or Debarred Persons List (as identified by the U.S. Treasury Office of Foreign Asset Control (OFAC) and by the U.S. Department of Commerce, Bureau of Industry and Security (BIS), or any other United States list of prohibited persons; is not owned or controlled by any person that is on one of those lists, or is otherwise prohibited by United States or other law from purchasing the products or services hereunder. Customer shall be solely responsible to obtain any license to export, re-export or import as may be required. Customer also agrees that it will not use these products in connection with the proliferation of weapons of mass destruction, including missiles, nuclear, chemical or biological weapons.

11. GENERAL

The Terms and Conditions may not be modified or cancelled without Pasternack's written agreement. Accordingly, goods furnished and services rendered by Pasternack are sold only on the terms and conditions stated herein. The Terms and Conditions will be governed by and construed in accordance with the laws of the State of California and the applicable laws of the United States of America. If Customer chooses to access the Pasternack website from outside the United States, Customer does so on their own initiative and is responsible for compliance with all applicable local laws.

12. INTELLECTUAL PROPERTY

The drawings, text, product depictions, logos, content, product descriptions, and organization and taxonomy of Pasternack's RF Product Guide and website and of the described content within the RF Product Guide and website are proprietary to Pasternack and protected by intellectual property laws, including but not limited to United States Copyright law and United States Trademark law. Pasternack owns copyrights in these referenced works as well as the selection, arrangement, coordination and structure of the arranged content and works within their RF Product Guide and website. Use of the RF Product Guide/website does not give you any right to modify, reproduce, transmit, publish, publicly display, adapt, or create derivative works or in any way exploit any of the materials and content of Pasternack's RF Product Guide or website.

WARNING: Products in this catalog can expose you to chemicals including phthalates, which are known to the State of California to cause cancer and birth defects or other reproductive harm. For more information, go to www.P65Warnings.ca.gov. For specific products impacted, please visit www.pasternack.com.

PART NUMBER INDEX

Note: C/R stands for the Column and/or Row location of the specific product on a given page.

Model No.	Page	C/R	Model No.	Page	C/R	Model No.	Page	C/R	Model No.	Page	C/R	Model No.	Page	C/R	Model No.	Page	C/R
PE9349	23	A5	PE9472	30	C6	PE9595	23	B6	PE9721	Web		PE9959	Web		PE9859-20	220	32
PE9350	23	C6	PE9473	Web		PE9596	35	C3	PE9722	30	C4	PE9960	Web		PE9859NF-20	221	92
PE9351	Web		PE9474	Web		PE9597	Web		PE9723	30	D4	PE9961	Web		PE9859SF-20	221	95
PE9352	Web		PE9475	33	D2	PE9598	35	A4	PE9724	32	C3	PE9962	Web		PE9860-10	220	33
PE9353	Web		PE9476	31	B1	PE9599	Web		PE9725	32	D3	PE9963	Web		PE9860NF-10	221	96
PE9354	Web		PE9477	33	A3	PE9600	35	C2	PE9726	32	A2	PE9964	Web		PE9860SF-10	221	99
PE9355	Web		PE9478	31	C1	PE9601	35	B3	PE9727	30	A3	PE9965	Web		PE9860-15	220	34
PE9356	Web		PE9479	22	B2	PE9602	35	D2	PE9728	30	B3	PE9966	Web		PE9860SF-15	221	91
PE9357	Web		PE9480	Web		PE9603	35	A3	PE9729	32	B2	PE9967	Web		PE9860NF-15	221	97
PE9358	Web		PE9481	23	A6	PE9604	35	B4	PE9730	27	A2	PE9972	Web		PE9860-20	220	35
PE9359	24	A2	PE9482	27	B1	PE9605	Web		PE9731	27	B2	PE9801	236	33	PE9860SF-20	221	2
PE9360	26	B4	PE9483	Web		PE9606	Web		PE9732	35	B3	PE9802	236	41	PE9860NF-20	221	98
PE9361	38	C3	PE9484	20	D4	PE9607	Web		PE9733	35	D3	PE9803	236	6	PE9861-10	220	36
PE9362	38	D3	PE9485	29	B3	PE9608	39	C1	PE9734	Web		PE9804	236	34	PE9861NF-10	221	3
PE9363	38	A4	PE9486	33	B5	PE9609	Web		PE9735	Web		PE9805	236	39	PE9861SF-10	221	6
PE9364	Web		PE9487	Web		PE9610	Web		PE9736	39	C6	PE9806	236	7	PE9861-15	220	37
PE9365	Web		PE9488	31	D3	PE9611	Web		PE9737	39	B4	PE9809	236	3	PE9861NF-15	221	4
PE9366	38	B4	PE9489	Web		PE9612	Web		PE9738	39	D3	PE9810	236	35	PE9861SF-15	221	7
PE9367	Web		PE9490	26	C1	PE9613	39	C5	PE9739	39	A5	PE9811	236	40	PE9861-20	220	38
PE9368	39	C4	PE9491	25	D1	PE9614	Web		PE9740	39	B5	PE9812	236	97	PE9861NF-20	221	5
PE9369	39	C3	PE9492	26	B2	PE9615	39	D5	PE9741	38	D6	PE9813A	236	96	PE9861SF-20	221	8
PE9370	Web		PE9493	Web		PE9616	Web		PE9742	Web		PE9815	236	19	PE9862-15	220	39
PE9371	Web		PE9494	32	A2	PE9617	Web		PE9743	38	C6	PE9816	236	15	PE9862NF-15	221	9
PE9372	Web		PE9495	30	D5	PE9618	Web		PE9744	39	A1	PE9820	236	55	PE9862SF-15	221	11
PE9373	Web		PE9496	32	C5	PE9619	Web		PE9745	17	A5	PE9821	237	72	PE9862-20	220	40
PE9374	Web		PE9497	Web		PE9620	29	B4	PE9746	Web		PE9822	237	79	PE9862NF-20	221	10
PE9375	40	C3	PE9498	Web		PE9621	28	C6	PE9747	14	D4	PE9823	237	82	PE9862SF-20	221	12
PE9376	40	A3	PE9499	31	D2	PE9622	Web		PE9748	18	B1	PE9824	237	86	PE9863-10	220	43
PE9377	40	B3	PE9500	24	C4	PE9623	40	A1	PE9749	27	C5	PE9826	237	86	PE9863NF-10	221	13
PE9378	28	D1	PE9501	15	B5	PE9624	40	B1	PE9750	19	B6	PE9827	236	89	PE9863-15	220	46
PE9379	28	D2	PE9502	15	A5	PE9625	40	B3	PE9751	Web		PE9828	236	1	PE9863-20	220	44
PE9380	29	D1	PE9503	15	A5	PE9626	Web		PE9752	19	C6	PE9830	237	69	PE9863NF-20	221	14
PE9381	Web		PE9504	15	A3	PE9627	Web		PE9753	19	D5	PE9831	237	73	PE9863SF-20	221	16
PE9382	24	D4	PE9505	28	B1	PE9628	Web		PE9754	19	D6	PE9832	237	80	PE9864-10	220	45
PE9383	24	D2	PE9506	Web		PE9629	Web		PE9755	19	A6	PE9833	237	83	PE9864NF-10	221	17
PE9384	Web		PE9507	29	A2	PE9630	Web		PE9756	19	A5	PE9834	237	85	PE9864SF-10	222	20
PE9385	Web		PE9508	20	A4	PE9631	40	A2	PE9757	19	B5	PE9835	237	81	PE9864-15	222	48
PE9386	Web		PE9509	Web		PE9632	Web		PE9758	20	A4	PE9836	236	54	PE9864NF-15	222	18
PE9387	Web		PE9510	Web		PE9633	Web		PE9759	38	C5	PE9838	237	71	PE9864SF-15	222	21
PE9388	Web		PE9511	31	D5	PE9634	Web		PE9760	Web		PE9839	237	74	PE9864-20	220	47
PE9389	26	C3	PE9512	34	A3	PE9635	Web		PE9761	38	A6	PE9840	237	81	PE9864NF-20	222	19
PE9390	Web		PE9513	Web		PE9637	Web		PE9762	Web		PE9842	237	87	PE9864SF-20	222	22
PE9391	39	A2	PE9515	Web		PE9638	Web		PE9763	Web		PE9843	237	91	PE9865	236	58
PE9392	Web		PE9516	Web		PE9639	Web		PE9764	Web		PE9846	236	19	PE9866	236	59
PE9393	Web		PE9517	Web		PE9640	35	B1	PE9765	Web		PE9849	236	15	PE9867-10	220	16
PE9394	Web		PE9518	23	C1	PE9642	28	C2	PE9766	Web		PE9848	236	36	PE9868	236	26
PE9395	Web		PE9519	Web		PE9644	16	C1	PE9767	Web		PE9850-10	220	2	PE9869	236	38
PE9396	39	A4	PE9520	Web		PE9645	16	A1	PE9768	17	B2	PE98502F-10	220	48	PE9870	236	56
PE9397	39	D4	PE9521	38	A1	PE9646	16	A2	PE9769	Web		PE9850-15	220	3	PE9871	236	43
PE9398	22	D1	PE9522	23	A1	PE9647	16	B2	PE9770	Web		PE98502F-15	220	49	PE9872	237	90
PE9399	34	B5	PE9523	Web		PE9648	16	D2	PE9771	24	B5	PE9850-20	220	4	PE9873	236	32
PE9400	Web		PE9524	Web		PE9649	16	D6	PE9772	Web		PE98502F-20	220	5	PE9874	236	16
PE9401	31	C5	PE9525	Web		PE9650	18	D1	PE9773	Web		PE9851-10	220	5	PE9875	236	10
PE9402	34	C5	PE9526	Web		PE9651	17	D5	PE9774	28	A4	PE98512F-10	221	51	PE9876	237	70
PE9403	Web		PE9527	Web		PE9652	18	B2	PE9775	Web		PE98512F-15	221	52	PE9877	237	84
PE9404	Web		PE9528	Web		PE9653	30	C3	PE9776	Web		PE98512F-20	221	53	PE9878	236	95
PE9405	27	A5	PE9529	Web		PE9654	30	D3	PE9777	36	D2	PE9851A-15	220	6	PE9879	236	2
PE9406	21	D1	PE9530	Web		PE9655	32	C2	PE9778	Web		PE9851A-20	220	7	PE9881-20	236	5
PE9407	32	A6	PE9531	37	C4	PE9656	32	C1	PE9779	Web		PE9852A-15	220	7	PE9881-24	6, 222	6
PE9408	33	A6	PE9532	37	D4	PE9657	17	A6	PE9780	Web		PE9852-10	220	8	PE9881-34	6, 222	8
PE9409	Web		PE9533	30	A1	PE9658	17	B6	PE9781	Web		PE98522F-10	221	54	PE9881-42	6, 222	7
PE9410	Web		PE9534	29	C6	PE9659	18	C2	PE9782	17	B1	PE98522F-15	221	55	PE9881A-20	222	26
PE9411	Web		PE9535	24	C6	PE9660	16	D6	PE9783	37	D5	PE9852-20	220	10	PE9882	237	88
PE9412	Web		PE9536	Web		PE9661	16	A5	PE9786	33	C6	PE98522F-20	221	56	PE9883	236	31
PE9413	22	D2	PE9537	Web		PE9662	16	B6	PE9787	25	C3	PE9853-10	220	11	PE9884	236	57
PE9414	19	B1	PE9538	Web		PE9663	17	C1	PE9788	26	A5	PE9853SF-10	221	57	PE9887-11	222	23
PE9415	35	D1	PE9539	26	B3	PE9664	17	D1	PE9789	25	D3	PE9854-20	220	14	PE9888-11	222	24
PE9416	39	A3	PE9540	Web		PE9665	16	C5	PE9807	Web		PE9853-15	220	12	PE9889	236	37
PE9417	39	D2	PE9541	24	A3	PE9666	16	C3	PE9808	Web		PE9853SF-15	221	58	PE9890	236	42
PE9418	28	B2	PE9542	Web		PE9667	16	B3	PE9813	Web		PE9853-20	220	13	PE9818	37	A5
PE9419	22	A2	PE9543	Web		PE9668	16	D5	PE9814	Web		PE9853SF-20	221	59	PE91001	Web	
PE9420	20	D5	PE9544	Web		PE9669	28	A3	PE9816	Web		PE9854-10	220	15	PE91002	32	C6
PE9421	Web		PE9545	Web		PE9670	29	B5	PE9817	Web		PE9854NF-10	221	60	PE91003	30	A6
PE9422	Web		PE9546	28	C3	PE9671	28	D6	PE9818	Web		PE9854SF-10	220	23	PE91004	Web	
PE9424	Web		PE9547	Web		PE9672	15	D1	PE9829	Web		PE9854-15	220	16	PE91005	35	A2
PE9425	Web		PE9548	Web		PE9673	15	C3	PE9836	Web		PE9854NF-15	221	61	PE91006	Web	
PE9426	23	B5	PE9549	Web		PE9674	15	A2	PE9845	Web		PE9854SF-15	221	64	PE91007	32	D1
PE9427	23	A4	PE9550	25	A6	PE9675	15	D3	PE9849	Web		PE9854-20	220	17	PE91008	30	B4
PE9428	24	D1	PE9551	Web		PE9676	17	C4	PE9851-20	Web		PE9854NF-20	221	62	PE91009	32	A3
PE9429	24	C3	PE9552	Web		PE9677	17	D3	PE9852-15	Web		PE9854SF-20	221	65	PE91010	30	A4
PE9430	Web		PE9553	Web		PE9678	17	B4	PE9852-20	Web		PE9855-10	220	18	PE91011	32	B3
PE9431	31	C1	PE9554	25	D2	PE9679	Web		PE9853	Web		PE9855NF-10	221	68	PE91012	Web	
PE9432	31	D2	PE9555	Web		PE9680	Web		PE9882NF-10	Web		PE9855SF-10	221	69	PE91028	Web	
PE9433	31	B3	PE9556	19	C1	PE9681	Web		PE9862SF-10	Web		PE9855-15	22				

PART NUMBER INDEX

Note: C/R stands for the Column and/or Row location of the specific product on a given page.

Model No.	Page	C/R	Model No.	Page	C/R	Model No.	Page	C/R	Model No.	Page	C/R	Model No.	Page	C/R	Model No.	Page	C/R
PE91073	38	B1	PE91216	Web		PE91402	20	C2	PEWCA1045	236	49	PEWCT1031	227		PEWGS6004	228	18
PE91074	Web		PE91217	Web		PE91403	35	C1	PEWCA1046	237	67	PEWCT1032	227		PEWGS6005	228	19
PE91075	Web		PE91218	Web		PE91404	Web		PEWCA1047	237	68	PEWCT1033	227		PEWGS6006	228	20
PE91076	Web		PE91219	Web		PE91405	Web		PEWCA1048	237	59	PEWCT1034	227		PEWGS6007	228	21
PE91077	Web		PE91220	Web		PE91407	Web		PEWCA1049	237	60	PEWCT1035	227		PEWGS6008	228	22
PE91078	Web		PE91222	28	C4	PE91408	Web		PEWCA1050	237	63	PEWCT1036	227		PEWGS6009	228	23
PE91079	Web		PE91225	28	D4	PE91409	Web		PEWCA1051	237	64	PEWCT1037	227		PEWGS6010	228	24
PE91080	40	B2	PE91227	Web		PE91410	Web		PEWCA1056	237	78	PEWCT1038	227		PEWGS6011	228	25
PE91081	Web		PE91228	Web		PE91411	Web		PEWCA1057	237	75	PEWCT1039	227		PEWGS6012	228	26
PE91082	Web		PE91229	Web		PE91493	Web		PEWCA1058	237	76	PEWCT1040	227		PEWGS6013	228	27
PE91083	40	C2	PE91230	Web		PE91413	Web		PEWCA1059	237	77	PEWCT1041	227		PEWGS6014	228	28
PE91084	14	C3	PE91231	Web		PE91414	Web		PEWCP1005	225	25	PEWCT1042	227		PEWGS6015	228	29
PE91085	14	C2	PE91232	Web		PE91415	Web		PEWCP1006	225	26	PEWCT1043	227		PEWGS6016	229	30
PE91086	14	A3	PE91233	Web		PE91416	Web		PEWCP1007	225	27	PEWCT1044	227		PEWGS6017	229	31
PE91087	38	D1	PE91234	Web		PE91419	Web		PEWCP1008	225	32	PEWCT1045	227		PEWGS6018	229	32
PE91088	Web		PE91235	23	B3	PE91420	Web		PEWCP1009	225	33	PEWCT1046	227		PEWGS6019	229	33
PE91089	Web		PE91236	Web		PE91436	38	C5	PEWCP1010	225	34	PEWCT1047	227		PEWGS6020	229	34
PE91090	Web		PE91237	Web		PE91433	34	A6	PEWCP1011	225	35	PEWCT1048	227		PEWGS6021	229	35
PE91091	Web		PE91238	24	A4	PE91434	36	B5	PEWCP1012	225	36	PEWCT1049	227		PEWGS6022	229	36
PE91092	Web		PE91239	Web		PE91436	36	A5	PEWCP1013	225	37	PEWCT1050	227		PEWGS6023	229	37
PE91093	18	D4	PE91240	Web		PE91444	19	D3	PEWCP1014	225	38	PEWCT1051	227		PEWGS6024	229	38
PE91094	Web		PE91241	Web		PE91446	Web		PEWCP1015	225	39	PEWCT1052	227		PEWGS6025	229	39
PE91095	Web		PE91242	37	D3	PE91447	38	A3	PEWCP1016	225	40	PEWCT1053	227		PEWGS6026	229	40
PE91099	Web		PE91243	Web		PE91448	38	B6	PEWCP1017	225	41	PEWCT1054	227		PEWGS6027	229	41
PE91103	Web		PE91244	Web		PE91458	34	A6	PEWCP1018	225	42	PEWCT1055	227		PEWGS6028	229	42
PE91102	Web		PE91245	Web		PEM001	Web		PEWCP1019	225	45	PEWCT1056	227		PEWIR1001	Web	
PE91103	Web		PE91246	Web		PEM001-MIM	5	2	PEWCP1020	225	42	PEWCT1057	227		PEWIR1002	Web	
PE91104	21	B1	PE91247	Web		PEM002	Web		PEWCP1021	225	44	PEWCT1058	227		PEWIR1003	Web	
PE91105	40	D6	PE91248	Web		PEM002-MIM	5	3	PEWCP1022	225	46	PEWCT1059	227		PEWIR1004	Web	
PE91106	40	B6	PE91249	19	C3	PEM003-KIT	Web		PEWCP1023	225	47	PEWCT1060	227		PEWIR1005	Web	
PE91107	40	C6	PE91250	Web		PEM004	6	10	PEWCP1024	225	49	PEWCT1061	227		PEWIR1006	Web	
PE91108	14	A1	PE91251	Web		PEM005	6	11	PEWCP1025	225	51	PEWCT1062	227		PEWIR1007	Web	
PE91109	14	A2	PE91252	Web		PEM009-KIT	5	5	PEWCP1026	225	48	PEWCT1063	227		PEWIR1008	Web	
PE91110	15	B2	PE91253	Web		PEM009-KIT TRANSMIT	5	4	PEWCP1027	225	50	PEWCT1064	227		PEWIR1009	Web	
PE91111	15	B4	PE91254	Web		PEM009-KIT-TX	Web		PEWCP1028	225	52	PEWCT1065	227		PEWIR1010	Web	
PE91112	15	A4	PE91255	Web		PEM11000-KIT	Web		PEWCP1029	225	53	PEWCT1066	227		PEWMT1000	231	23
PE91113	16	C2	PE91256	Web		PEM11000-KIT	6	13	PEWCP1030	225	55	PEWCT1067	227		PEWMT1001	231	24
PE91114	23	C4	PE91257	Web		PEM11002-KIT	6	12	PEWCP1031	226	57	PEWCT1068	227		PEWMT1002	231	25
PE91115	14	D3	PE91258	29	D3	PEM11002-KIT	6	12	PEWCP1032	226	54	PEWCT1069	227		PEWMT1003	231	26
PE91116	Web		PE91259	29	B6	PETP1000	201	20	PEWCP1033	226	56	PEWCT1070	227		PEWMT1004	231	27
PE91117	19	A1	PE91260	30	B1	PETP1001	201	19	PEWCP1034	226	58	PEWCT1071	227		PEWMT1005	231	28
PE91118	14	B1	PE91261	30	D1	PETP1002	201	23	PEWCP1035	226	59	PEWCT1072	227		PEWMT1006	231	29
PE91119	14	D1	PE91262	30	B2	PETP1003	201	24	PEWCP1036	226	60	PEWCT1073	227		PEWSP1000	233	5
PE91120	15	D2	PE91263	30	C1	PETP1004	201	26	PEWCP1037	226	61	PEWCT1074	227		PEWSP1001	233	6
PE91121	Web		PE91264	29	D6	PETP1005	201	27	PEWCP1038	226	62	PEWCT1075	227		PEWSP1002	233	7
PE91122	15	C4	PE91265	Web		PETP1006	201	30	PEWCP1039	226	63	PEWCT1076	227		PEWSP1003	234	8
PE91123	15	D4	PE91266	Web		PETP1007	201	31	PEWCP1040	226	64	PEWCT1077	227		PEWSP1004	234	9
PE91124	Web		PE91267	Web		PETP1008	201	34	PEWCP1041	226	65	PEWCT1078	227		PEWSP1005	234	10
PE91125	Web		PE91268	Web		PETP1009	201	35	PEWCP1042	226	66	PEWCT1079	227		PEWSP1006	234	11
PE91126	16	D4	PE91269	Web		PETP1010	202	38	PEWCP1043	226	67	PEWCT1080	227		PEWSP1007	234	12
PE91127	17	A1	PE91270	Web		PETP1011	202	39	PEWCP1044	226	68	PEWCT1081	227		PEWSP1008	234	13
PE91128	Web		PE91290	29	D5	PETP1012	202	49	PEWCP1045	226	69	PEWCT1082	227		PEWSP1009	234	14
PE91129	33	A2	PE91291	18	A2	PETP1013	202	50	PEWCP1046	226	70	PEWCT1083	227		PEWSP1010	234	15
PE91134	26	A1	PE91292	17	C5	PETP1014	202	54	PEWCP1047	226	71	PEWCT1084	227		PEWSP1011	234	16
PE91135	15	C2	PE91293	17	C5	PETP1015	202	55	PEWCP1048	226	72	PEWCT1085	227		PEWSP1012	234	17
PE91136	15	C2	PE91294	Web		PETP1016	202	58	PEWCP1049	226	73	PEWCT1086	227		PEWTR1000	234	25
PE91137	14	A6	PE91295	16	B6	PETP1017	202	59	PEWCP1050	226	74	PEWCT1087	227		PEWTR1001	234	26
PE91138	14	C6	PE91296	Web		PEWAD5000	223	67	PEWCP1051	226	75	PEWCT1088	227		PEWTR1002	234	27
PE91139	15	A1	PE91297	Web		PEWAD5002	223	69	PEWCP1052	226	76	PEWCT1089	227		PEWTR1003	234	28
PE91140	Web		PE91298	16	D3	PEWAD5003	223	70	PEWCP1053	226	77	PEWCT1090	227		PEWTR1004	234	29
PE91141	24	C1	PE91299	33	C1	PEWAD5004	223	72	PEWCP1054	226	78	PEWCT1091	227		PEWTR1005	234	30
PE91144	Web		PE91300	33	D1	PEWAD5005	223	79	PEWCP1055	226	79	PEWCT1092	227		PEWTR1006	235	57
PE91145	15	A6	PE91301	33	B2	PEWAD5006	223	74	PEWCP1056	226	81	PEWCT1093	227		PEWTR1007	235	58
PE91146	15	B6	PE91302	30	D6	PEWAD5006	223	77	PEWCP1057	226	83	PEWCT1094	227		PEWTR1008	235	59
PE91147	18	D3	PE91303	Web		PEWAD5007	223	71	PEWCP1058	226	85	PEWCT1095	227		PEWTR1009	235	60
PE91148	Web		PE91304	Web		PEWAD5008	223	73	PEWCP1059	226	86	PEWCT1096	227		PEWTR1010	235	70
PE91149	28	B5	PE91305	34	C1	PEWAD5009	223	75	PEWCP1060	226	82	PEWCT1097	227		PEWTR1011	235	71
PE91150	29	A3	PE91306	34	D1	PEWAD5010	223	76	PEWCP1061	226	84	PEWCT1098	227		PEWTR1012	235	72
PE91151	28	A2	PE91307	34	D1	PEWAD5011	223	78	PEWCP1062	226	86	PEWCT1099	227		PEWTR1013	235	73
PE91152	28	C5	PE91308	34	C4	PEWAD5012	223	79	PEWCP1063	226	87	PEWCT1100	227		PEWTR1014	235	74
PE91153	Web		PE91309	31	D4	PEWAD5013	223	80	PEWCP1064	226	89	PEWCT1101	227		PEWTR1015	235	75
PE91154	28	C1	PE91310	31	A5	PEWAD5014	223	81	PEWCP1065	226	91	PEWCT1102	227		PEWTR1016	235	76
PE91155	28	B4	PE91311	31	B5	PEWAD5015	223	82	PEWCP1066	226	93	PEWCT1103	227		PEWTR1017	235	77
PE91156	29	C2	PE91312	Web		PEWAD5016	223	83	PEWCP1067	226	88	PEWCT1104	227		PEWTR1018	235	78
PE91157	Web		PE91321	29	A1	PEWAD5017	223	84	PEWCP1068	226	90	PEWCT1105	227		PEWTR1019	235	79
PE91158	14	A4	PE91324	38	D4	PEWAD5018	224	85	PEWCP1069	226	92	PEWCT1106	227		PEWTR1020	235	80
PE91159	Web		PE91325	29	D2	PEWAD5019	224	86	PEWCP1070	226	94	PEWCT1107	227		PEWTR1021	235	81
PE91160	14	B4	PE91327	28	D1	PEWAN1001	220	42	PEWCP1071	226	95	PEWCT1108	227		PEWTR1022	235	82
PE91161	Web		PE91328	38	D2	PEWAT1000-30	Web		PEWCP1072	226	97	PEWCT1109	227		PEWTR1023	235	83
PE91162	Web		PE91329	Web		PEWAT1001-30	Web		PEWCP1073								

50-OHM CONVERSION TABLE

(dBm - volts- watts)

dBm	V	Po
+53	100.0	200W
+50	70.7	100W
+49	64.0	80W
+48	58.0	64W
+47	50.0	50W
+46	44.5	40W
+45	40.0	32W
+44	32.5	25W
+43	32.0	20W
+42	28.0	16W
+41	26.2	12.5W
+40	22.5	10W
+39	20.0	8W
+38	18.0	6.4W
+37	16.0	5W
+36	14.1	4W
+35	12.5	3.2W
+34	11.5	2.5W
+33	10.0	2W
+32	9.0	1.6W
+31	8.0	1.25W
+30	7.10	1.0W
+29	6.40	800 mW
+28	5.80	640 mW
+27	5.00	500 mW
+26	4.45	400 mW
+25	4.00	320 mW
+24	3.55	250 mW
+23	3.20	200 mW
+22	2.80	160 mW
+21	2.52	125 mW
+20	2.25	100 mW
+19	2.00	80 mW
+18	1.80	64 mW
+17	1.60	50 mW
+16	1.41	40 mW
+15	1.25	32 mW
+14	1.15	25 mW
+13	1.00	20 mW
+12	0.90	16 mW
+11	0.80	12.5 mW
+10	0.71	10 mW
+9	0.64	8 mW
+8	0.58	6.4 mW
+7	0.50	5 mW
+6	0.45	4 mW
+5	0.40	3.2 mW
+4	0.36	2.5 mW
+3	0.32	2.0 mW

dBm	V	Po
+2	0.28	1.6 mW
+1	0.25	1.25 mW
0	0.23	1.0 mW
-1	0.20	.80 mW
-2	0.18	.64 mW
-3	0.16	.50 mW
-4	0.14	.40 mW
-5	0.13	.32 mW
-6	0.12	.25 mW
-7	0.10	.20 mW
-8	0.09	.16 mW
-9	0.08	.125 mW
-10	0.07	.10 mW
-11	0.06	
-12	0.06	
-13	0.05	
-14	0.05	
-15	0.04	
-16	0.0355	
dBm	mV	Po
-17	31.5	
-18	28.5	
-19	25.1	
-20	22.5	.01 mW
-21	20.0	
-22	17.9	
-23	15.9	
-24	14.1	
-25	12.8	
-26	11.5	
-27	10.0	
-28	8.9	
-29	8.0	
-30	7.1	.001 mW
-31	6.25	
-32	5.8	
-33	5.0	
-34	4.5	
-35	4.0	
-36	3.5	
-37	3.2	
-38	2.85	
-39	2.5	
-40	2.25	.1 μ W
-41	2.0	
-42	1.8	
-43	1.6	
-44	1.4	
-45	1.25	

dBm	mV	Po
-46	1.18	
-47	1.0	
-48	0.9	
-49	0.8	
-50	0.71	.01 μ W
-51	0.64	
-52	0.57	
-53	0.5	
-54	0.45	
-55	0.4	
-56	0.351	
-57	0.32	
-58	0.286	
-59	0.251	
-60	0.225	.001 μ W
-61	0.2	
-62	0.18	
-63	0.16	
-64	0.141	
dBm	μ V	Po
-65	128	
-66	115	
-67	100	
-68	90	
-69	80	
-70	71	.1 nW
-71	65	
-72	58	
-73	50	
-74	45	
-75	40	
-76	35	
-77	32	
-78	29	
-79	25	
-80	22.5	.01 nW
-81	20	
-82	18	
-83	16	
-84	11.1	
-85	12.9	
-86	11.5	
-87	10.0	
-88	9.0	
-89	8.0	
-90	7.1	.001 nW
-91	6.1	
-92	5.75	
-93	5.0	

dBm	μ V	Po
-94	4.5	
-95	4.0	
-96	3.51	
-97	3.2	
-98	2.9	
-99	2.51	
-100	2.25	.1 pW
-101	2.0	
-102	1.8	
-103	1.6	
-104	1.41	
-105	1.27	
-106	1.18	
dBm	nV	Po
-107	1000	
-108	900	
-109	800	
-110	710	.01 pW
-109	640	
-112	580	
-113	500	
-114	450	
-115	400	
-116	355	
-117	825	
-118	285	
-119	251	
-120	225	.001 pW
-121	200	
-122	180	
-123	160	
-124	141	
-125	128	
-126	117	
-127	100	
-128	90	
-129	80	
-130	71	.1 fW
-131	61	
-132	58	
-133	50	
-134	45	
-135	40	
-136	35	
-137	33	
-138	29	
-139	25	
-140	23	.01 fW



Free Shipping Available
via UPS Ground to
USA & Canada



Technical
Support
(866) 727-8376



Same-Day Shipping,
Even Custom
Cable Assemblies

RETURN LOSS CONVERSION TABLE

Return Loss (dBm)	VSWR	Return Loss (dBm)	VSWR	Return Loss (dBm)	VSWR	Return Loss (dBm)	VSWR	Return Loss (dBm)	VSWR
46.064	1.01	13.842	1.51	9.485	2.01	7.327	2.51	5.999	3.01
40.086	1.02	13.708	1.52	9.428	2.02	7.294	2.52	5.970	3.02
36.607	1.03	13.577	1.53	9.372	2.03	7.262	2.53	5.956	3.03
34.151	1.04	13.449	1.54	9.317	2.04	7.230	2.54	5.935	3.04
32.256	1.05	13.324	1.55	9.262	2.05	7.198	2.55	5.914	3.05
30.714	1.06	13.201	1.56	9.208	2.06	7.167	2.56	5.893	3.06
29.417	1.07	13.081	1.57	9.155	2.07	7.135	2.57	5.872	3.07
28.299	1.08	12.964	1.58	9.103	2.08	7.105	2.58	5.852	3.08
27.318	1.09	12.849	1.59	9.051	2.09	7.074	2.59	5.832	3.09
26.444	1.10	12.736	1.60	8.999	2.10	7.044	2.60	5.811	3.10
25.658	1.11	12.625	1.61	8.949	2.11	7.014	2.61	5.791	3.11
24.943	1.12	12.518	1.62	8.899	2.12	6.984	2.62	5.771	3.12
24.289	1.13	12.412	1.63	8.849	2.13	6.954	2.63	5.751	3.13
23.686	1.14	12.308	1.64	8.800	2.14	6.925	2.64	5.732	3.14
23.127	1.15	12.207	1.65	8.752	2.15	6.896	2.65	5.712	3.15
22.607	1.16	12.107	1.66	8.705	2.16	6.867	2.66	5.693	3.16
22.120	1.17	12.009	1.67	8.657	2.17	6.839	2.67	5.674	3.17
21.664	1.18	11.913	1.68	8.611	2.18	6.811	2.68	5.654	3.18
21.234	1.19	11.818	1.69	8.565	2.19	6.783	2.69	5.635	3.19
20.828	1.20	11.725	1.70	8.519	2.20	6.755	2.70	5.617	3.20
20.443	1.21	11.634	1.71	8.474	2.21	6.728	2.71	5.598	3.21
20.079	1.22	11.545	1.72	8.430	2.22	6.700	2.72	5.579	3.22
19.732	1.23	11.457	1.73	8.386	2.23	6.673	2.73	5.561	3.23
19.401	1.24	11.370	1.74	8.342	2.24	6.646	2.74	5.542	3.24
19.085	1.25	11.285	1.75	8.299	2.25	6.620	2.75	5.524	3.25
18.783	1.26	11.202	1.76	8.257	2.26	6.594	2.76	5.506	3.26
18.493	1.27	11.120	1.77	8.215	2.27	6.567	2.77	5.488	3.27
18.216	1.28	11.039	1.78	8.173	2.28	6.541	2.78	5.470	3.28
17.949	1.29	10.960	1.79	8.138	2.29	6.516	2.79	5.452	3.29
17.690	1.30	10.881	1.80	8.091	2.30	6.490	2.80	5.435	3.30
17.445	1.31	10.804	1.81	8.051	2.31	6.465	2.81	5.417	3.31
17.207	1.32	10.729	1.82	8.011	2.32	6.440	2.82	5.400	3.32
16.977	1.33	10.654	1.83	7.972	2.33	6.415	2.83	5.383	3.33
16.755	1.34	10.581	1.84	7.933	2.34	6.390	2.84	5.365	3.34
16.540	1.35	10.509	1.85	7.894	2.35	6.366	2.85	5.348	3.35
16.332	1.36	10.437	1.86	7.856	2.36	6.341	2.86	5.331	3.36
16.131	1.37	10.367	1.87	7.818	2.37	6.317	2.87	5.315	3.37
15.936	1.38	10.298	1.88	7.781	2.38	6.293	2.88	5.298	3.38
15.747	1.39	10.230	1.89	7.744	2.39	6.270	2.89	5.281	3.39
15.563	1.40	10.163	1.90	7.707	2.40	6.246	2.90	5.265	3.40
15.385	1.41	10.097	1.91	7.671	2.41	6.223	2.91	5.248	3.41
15.211	1.42	10.032	1.92	7.635	2.42	6.200	2.92	5.232	3.42
15.043	1.43	9.968	1.93	7.599	2.43	6.177	2.93	5.216	3.43
14.879	1.44	9.904	1.94	7.564	2.44	6.154	2.94	5.200	3.44
14.719	1.45	9.842	1.95	7.529	2.45	6.131	2.95	5.184	3.45
14.564	1.46	9.780	1.96	7.494	2.46	6.109	2.96	5.168	3.46
14.412	1.47	9.720	1.97	7.460	2.47	6.086	2.97	5.152	3.47
14.264	1.48	9.660	1.98	7.426	2.48	6.064	2.98	5.137	3.48
14.120	1.49	9.601	1.99	7.393	2.49	6.042	2.99	5.121	3.49
13.979	1.50	9.542	2.00	7.360	2.50	6.021	3.00	5.105	3.50

MOUNTING HOLES

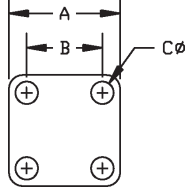

CODE	A	B	C
A01	.500	.340	.102
A02	.687	.500	.109
A03	.687	.500	#3-56 TAP
A04	.687	.500	.125
A05	1.000	.718	.125
A06	.750	.531	.140
A07	.750	.531	.125
A08	1.190	.906	.125
A09	.687	.500	#4-40 TAP
A10	.687	.500	.136
A11	1.250	.975	.147
A12	2.000	1.440	.257
A13	1.000	.718	.141
A14	1.000	.718	.144
A15	.687	.500	.104
A16	.750	.531	.136
A17	.375	.232	.067
A18	.625	.437	.094
A19	1.000	.718	#6-32 TAP
A20	.500	.340	#2-56 TAP
A21	1.250	.975	.142
A22	.375	.232	.093

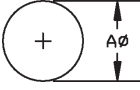

CODE	A
F01	.250
F02	.500
F03	.630
F04	1.200
F05	.380
F06	.450
F07	.200
F08	.362
F09	.220
F10	.317
F11	4.83mm
F12	.390

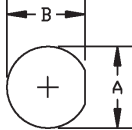

CODE	A	B
B01	.195	.177
B02	.250	.235
B03	.330	.295
B04	.380	.350
B05	.440	.410
B06	.512	.480
B07	.760	.720
B08	.565	.537
B09	.314	.296
B10	.140	.126
B11	.695	.655
B12	.625	.575
B13	.405	.361
B14	.277	.252
B15	.630	.596
B16	.317	.285
B17	.284	.268

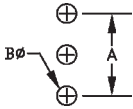

CODE	A	B
J01	.200	.046

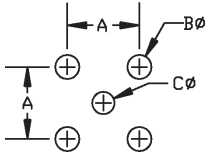

CODE	A	B	C
D01	.200	.067	.062
D02	.200	.067	.046
D03	.100	.031	.031
D04	.200	.052	.052
D05	.260	.067	.043
D06	.200	.052	.047
D07	.200	.055	.043
D08	.200	.067	.035
D09	.200	.055	.028
D10	.200	.055	.035
D11	.320	.091	.031
D12	.400	.062	.062
D13	.320	.091	.091
D14	.340	.091	.043
D15	.164	.067	.091
D16	.500	.126	.440
D17	.380	.083	.043

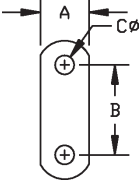

CODE	A	B	C
C01	.223	.481	.102
C02	.260	.481	.102
C03	.192	.328	.067
C04	.640	1.000	.125
C05	.275	.481	.102
C06	.230	.354	.067
C07	.188	.328	.093

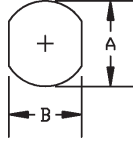

CODE	A	B
G01	.640	.546
G02	.380	.340
G03	.765	.712
G04	.362	.323
G05	.236	.197
G06	.217	.177
G07	.380	.310
G08	1.161	1.000

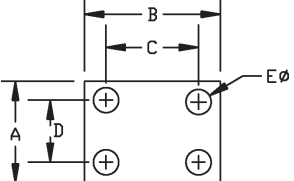

CODE	A	B	C	D	E
E01	.375	.500	.340	.222	.093

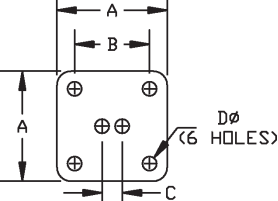

CODE	A	B	C	D
H01	.687	.500	.125	.045



Free Shipping Available
via UPS Ground to
USA & Canada



Technical
Support
(866) 727-8376



Same-Day Shipping,
Even Custom
Cable Assemblies

CONNECTOR IDENTIFIER

SPECIFICATIONS SHOWN ARE INTENDED FOR IDENTIFICATION PURPOSES ONLY

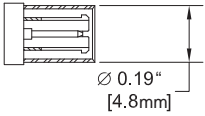
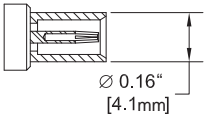
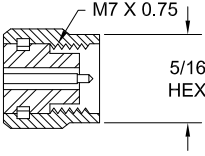
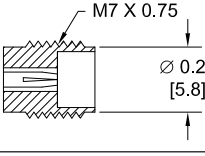
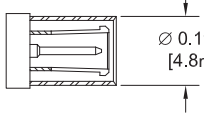
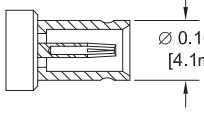
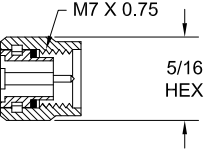
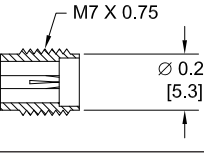
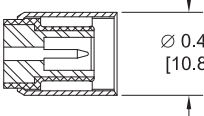
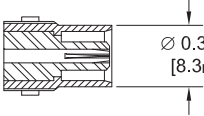
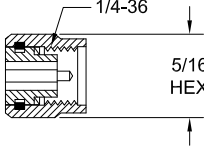
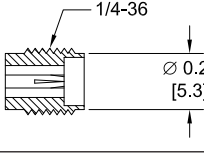
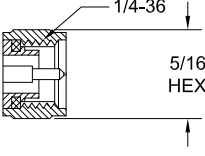
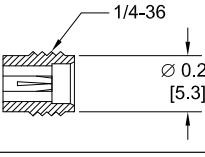
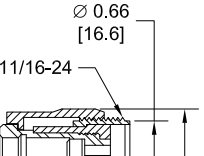
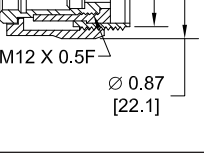
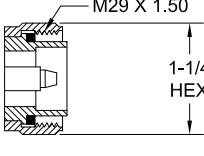
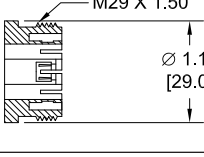
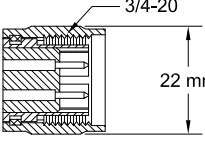
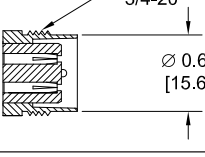
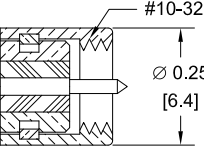
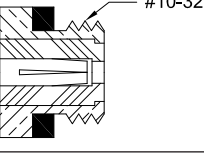
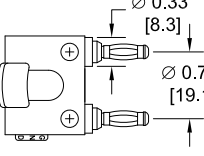
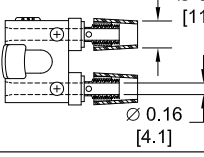
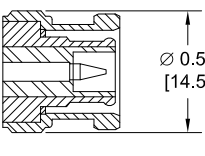
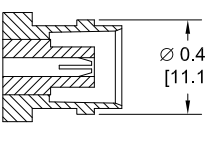
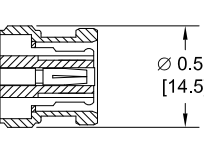
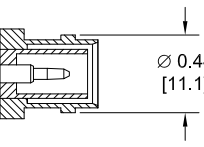
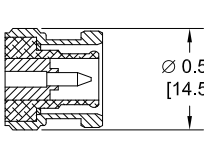
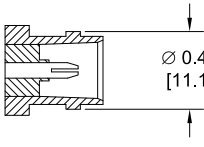









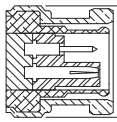
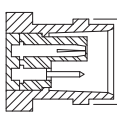
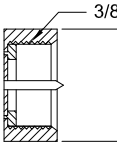
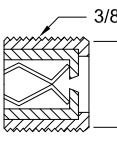
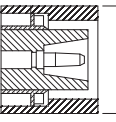
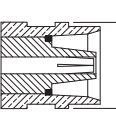
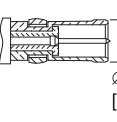
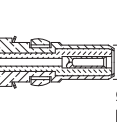
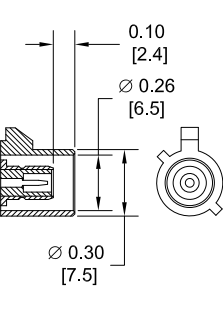
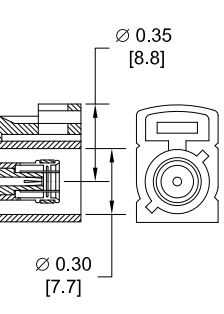





1.0/2.3 SLIDE ON	PLUG	
	JACK	
1.85 mm**	MALE	
	FEMALE	
1.0/2.3 SNAP ON	PLUG	
	JACK	
2.4 mm**	MALE	
	FEMALE	
1.6/56	PLUG	
	JACK	
2.92 mm**	MALE	
	FEMALE	
3.5 mm**	MALE	
	FEMALE	
7 mm	PLUG	
	JACK	
7/16	PLUG	
	JACK	
3/4-20 TWINAX	MALE	
	FEMALE	
10 - 32	MALE	
	FEMALE	
BANANA	PLUG	
	JACK	
BNC	MALE	
	FEMALE	
REVERSE POLARITY BNC	MALE	
	FEMALE	
75 OHM BNC	MALE	
	FEMALE	

*SMA, 2.92mm, & 3.5mm CONNECTORS WILL MATE MECHANICALLY & ELECTRICALLY TO EACH OTHER.

**1.85mm & 2.4mm CONNECTORS WILL MATE MECHANICALLY & ELECTRICALLY TO EACH OTHER.

CONNECTOR IDENTIFIER

SPECIFICATIONS SHOWN ARE INTENDED FOR IDENTIFICATION PURPOSES ONLY

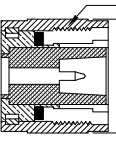
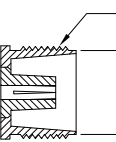
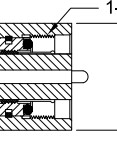
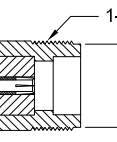
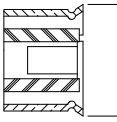
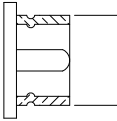
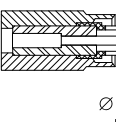
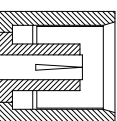
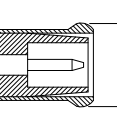
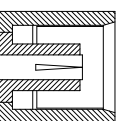
BNC TWINAX	PLUG	 Ø 0.57" [14.5mm]				
	JACK	 Ø 0.44" [11.1mm]				
F	MALE	 3/8-32 7/16 HEX				
	FEMALE	 3/8-32 Ø 0.34 [8.5]				
C	MALE	 Ø 0.75" [19.1mm]				
	FEMALE	 Ø 0.60" [15.2mm]				
D SUBMINIATURE	PLUG	 Ø 0.19" [4.8mm]				
	RECEPTACLE	 Ø 0.15" [3.9mm]				
FAKRA	PLUG	 0.10 [2.4] Ø 0.26 [6.5] Ø 0.30 [7.5]				
	JACK	 Ø 0.35 [8.8] Ø 0.30 [7.7]				
FAKRA	COMPLETE KEY CODE INFO	CODE	JACK	PLUG	COLOR	APPLICATION
		A			BLACK	RADIO WITH PHANTOM SUPPLY
		B			WHITE	RADIO WITHOUT PHANTOM SUPPLY
		C			BLUE	GPS: TELEMATICS OR NAVIGATION
D			BORDEAUX	GSM: CELLULAR PHONE		
H			VIOLET	GPS: TELEMATICS AND NAVIGATION		
I			BEIGE	BLUETOOTH		
K			CURRY	RADIO WITH I.F. OUTPUT (ANTENNA DIVERSITY)		
Z			WATER BLUE	NEUTRAL CODING		
GR874	MALE	 3/4-20 Ø 0.90 [22.9]				
	FEMALE	 3/4-20 Ø 0.67 [17.1]				
LC	MALE	 1-1/4-18 1-1/2 HEX				
	FEMALE	 1-1/4-18 Ø 1.17 [29.6]				
UMCX	PLUG	 Ø 0.10 [2.5]				
	JACK	 Ø 0.08 [2.0]				
MC-CARD	PLUG	 Ø 0.087 [2.2]				
	JACK	 Ø 0.20 [5.0]				
MCX	PLUG	 Ø 0.15 [3.7]				
	JACK	 Ø 0.20 [5.0]				

CONNECTOR IDENTIFIER

SPECIFICATIONS SHOWN ARE INTENDED FOR IDENTIFICATION PURPOSES ONLY

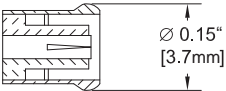
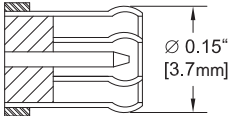
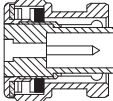
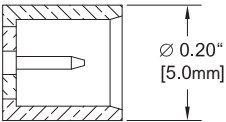
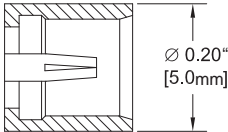
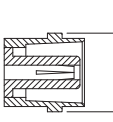
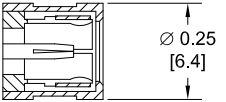
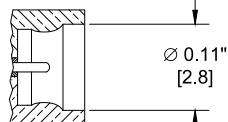
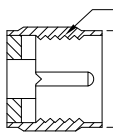
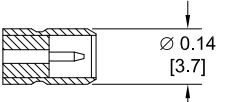
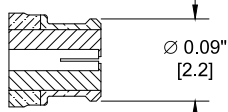
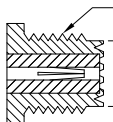
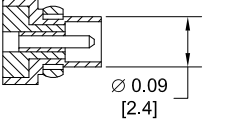
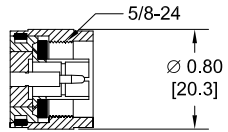
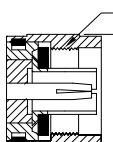
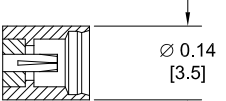
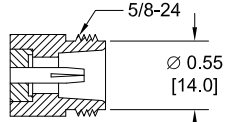
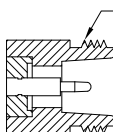
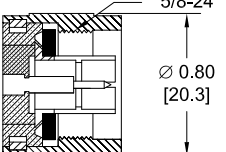
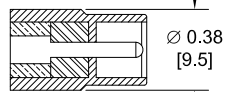
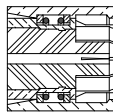
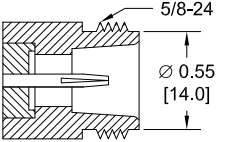
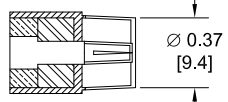
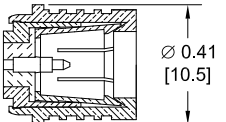
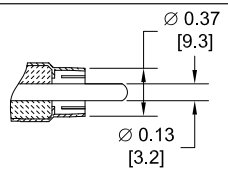
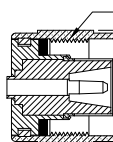
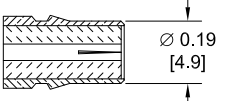
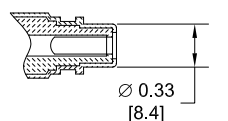
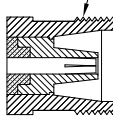
REVERSE POLARITY MCX	PLUG	 Ø 0.15" [3.7mm]	75 OHM MCX	PLUG	 Ø 0.15" [3.7mm]	MHV	MALE	 Ø 0.57" [14.5mm]
	JACK	 Ø 0.20" [5.0mm]		JACK	 Ø 0.20" [5.0mm]		FEMALE	 Ø 0.44" [11.1mm]
MINI 75 OHM SMB	PLUG	 Ø 0.25 [6.4]	MINI SMP	MALE	 Ø 0.11" [2.8]	MINI-UHF	MALE	 3/8-24 Ø 0.45 [11.5]
	JACK	 Ø 0.14 [3.7]		FEMALE	 Ø 0.09" [2.2]		FEMALE	 3/8-24 Ø 0.31 [7.8]
MMCX	PLUG	 Ø 0.09 [2.4]	N	MALE	 5/8-24 Ø 0.80 [20.3]	REVERSE POLARITY N	MALE	 5/8-24 Ø 0.80 [20.3]
	JACK	 Ø 0.14 [3.5]		FEMALE	 5/8-24 Ø 0.55 [14.0]		FEMALE	 5/8-24 Ø 0.55 [14.0]
75 OHM N	MALE	 5/8-24 Ø 0.80 [20.3]	PAL	PLUG	 Ø 0.38 [9.5]	POSITIVE SNAP	 Ø 0.39 [9.9]	
	FEMALE	 5/8-24 Ø 0.55 [14.0]		JACK	 Ø 0.37 [9.4]			
OMA	MALE	 Ø 0.41 [10.5]	RCA	PLUG	 Ø 0.37 [9.3] Ø 0.13 [3.2]	SC	MALE	 11/16-24 Ø 0.80 [20.3]
	FEMALE	 Ø 0.19 [4.9]		JACK	 Ø 0.33 [8.4]		FEMALE	 11/16-24 Ø 0.63 [15.9]

CONNECTOR IDENTIFIER

SPECIFICATIONS SHOWN ARE INTENDED FOR IDENTIFICATION PURPOSES ONLY

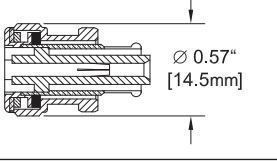
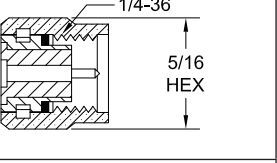
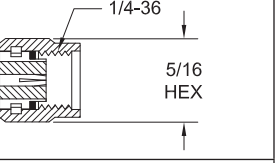
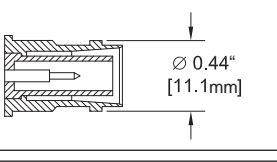
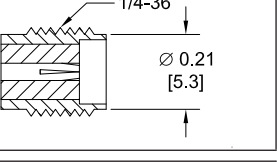
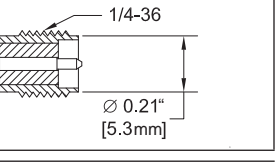
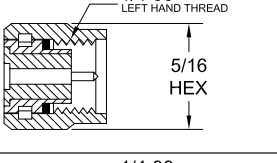
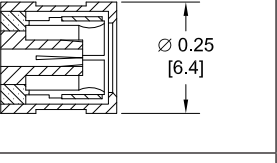
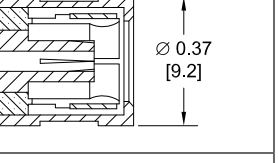
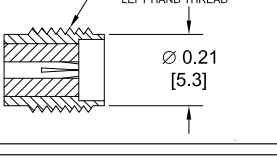
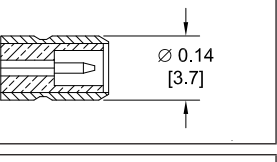
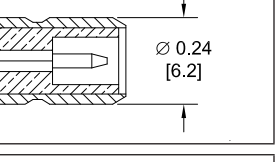
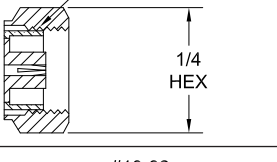
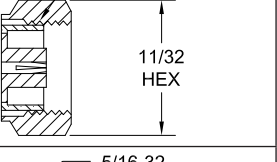
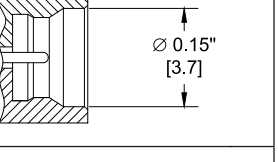
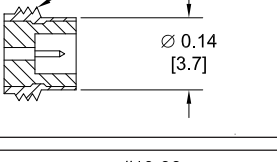
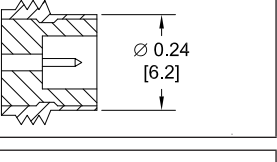
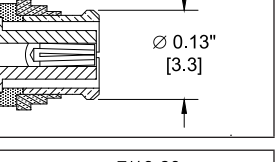
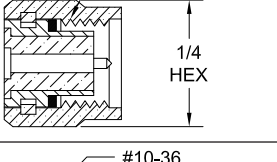
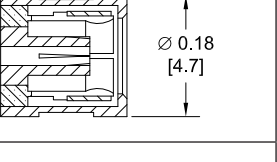
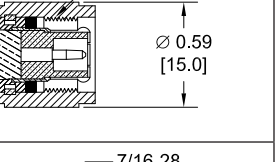
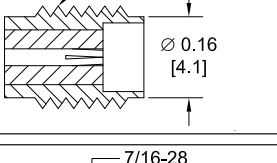
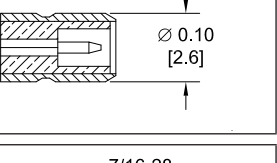
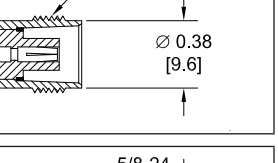
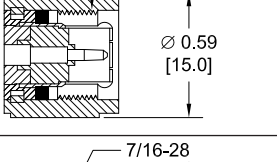
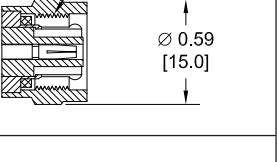
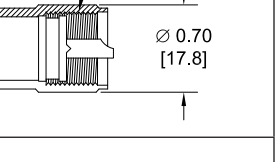
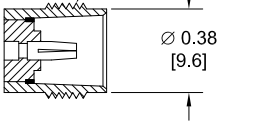
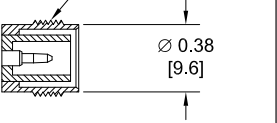
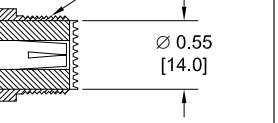
SHV	PLUG	 Ø 0.57" [14.5mm]	SMA*	MALE	 1/4-36 5/16 HEX	REVERSE POLARITY SMA	MALE	 1/4-36 5/16 HEX
	JACK	 Ø 0.44" [11.1mm]		FEMALE	 1/4-36 Ø 0.21 [5.3]		FEMALE	 1/4-36 Ø 0.21" [5.3mm]
SMA REVERSE THREAD	MALE	 1/4-36 LEFT HAND THREAD 5/16 HEX	SMB	PLUG	 Ø 0.25 [6.4]	75 OHM SMB	PLUG	 Ø 0.37 [9.2]
	FEMALE	 1/4-36 LEFT HAND THREAD Ø 0.21 [5.3]		JACK	 Ø 0.14 [3.7]		JACK	 Ø 0.24 [6.2]
SMC	PLUG	 #10-32 1/4 HEX	75 OHM SMC	PLUG	 5/16-32 11/32 HEX	SMP	MALE	 Ø 0.15" [3.7]
	JACK	 #10-32 Ø 0.14 [3.7]		JACK	 5/16-32 Ø 0.24 [6.2]		FEMALE	 Ø 0.13" [3.3]
SSMA	MALE	 #10-36 1/4 HEX	SSMB	PLUG	 Ø 0.18 [4.7]	TNC	MALE	 7/16-28 Ø 0.59 [15.0]
	FEMALE	 #10-36 Ø 0.16 [4.1]		JACK	 Ø 0.10 [2.6]		FEMALE	 7/16-28 Ø 0.38 [9.6]
75 OHM TNC	MALE	 7/16-28 Ø 0.59 [15.0]	REVERSE POLARITY TNC	MALE	 7/16-28 Ø 0.59 [15.0]	UHF	MALE	 5/8-24 Ø 0.70 [17.8]
	FEMALE	 7/16-28 Ø 0.38 [9.6]		FEMALE	 7/16-28 Ø 0.38 [9.6]		FEMALE	 5/8-24 Ø 0.55 [14.0]

*SMA, 2.92mm & 3.5mm CONNECTORS WILL MATE MECHANICALLY & ELECTRICALLY TO EACH OTHER.



Free Shipping Available
via UPS Ground to
USA & Canada



Technical
Support
(866) 727-8376



Same-Day Shipping,
Even Custom
Cable Assemblies

CONNECTOR FREQUENCY RANGE CHART

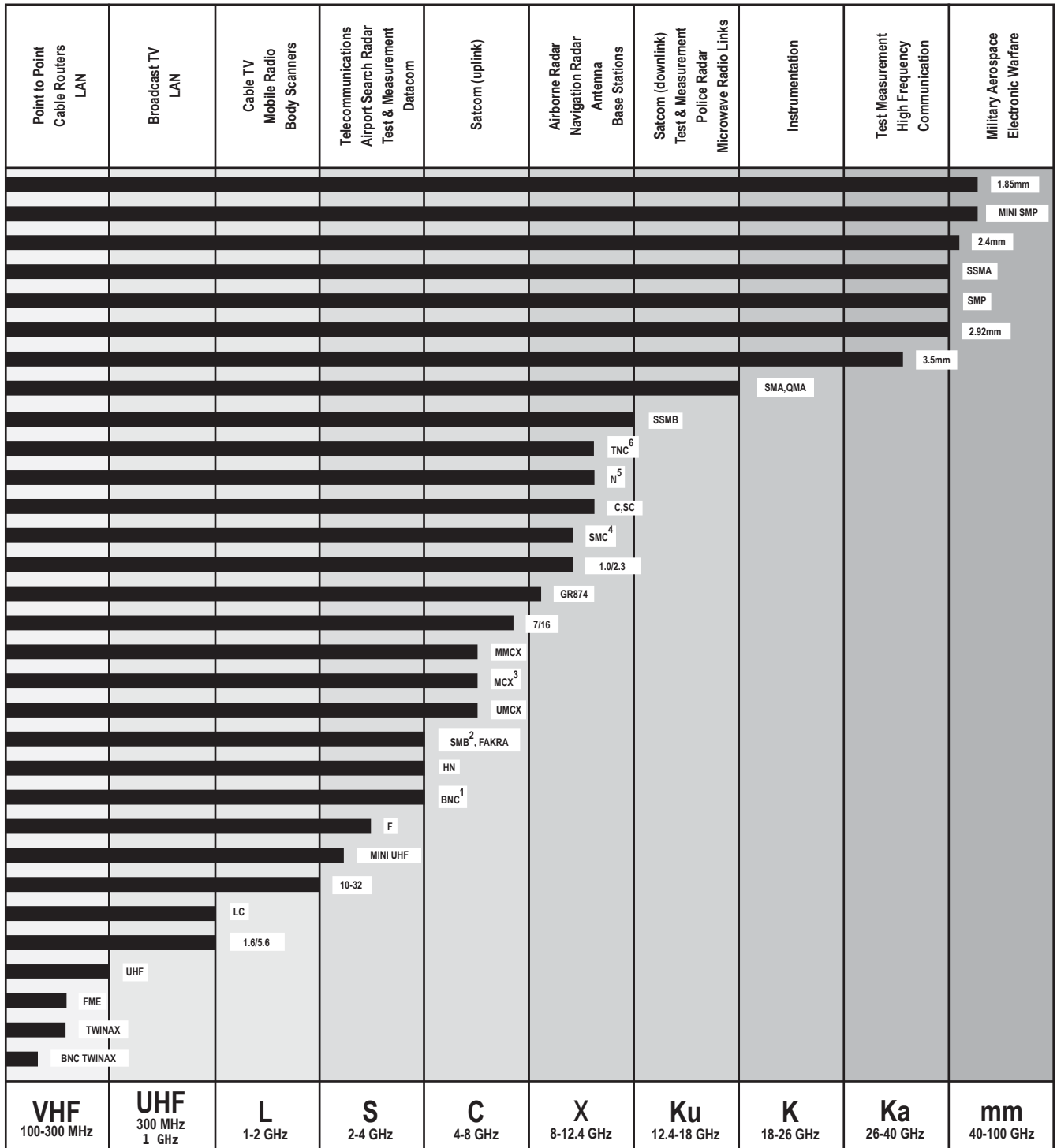

Notes:

- 1: BNC-75 Ohm connectors operate up to 1 GHz
- 2: SMB-75 Ohm & Mini SMB-75 Ohm connectors operate up to 4 GHz
- 3: MCX-75 Ohm connectors operate up to 6 GHz
- 4: SMC-75 Ohm connectors operate up to 10 GHz
- 5: N-75 Ohm connectors operate up to 1.5 GHz
- 6: TNC-75 Ohm connectors operate up to 1 GHz