

Pasternack

RF Product Guide 2019

Connectors

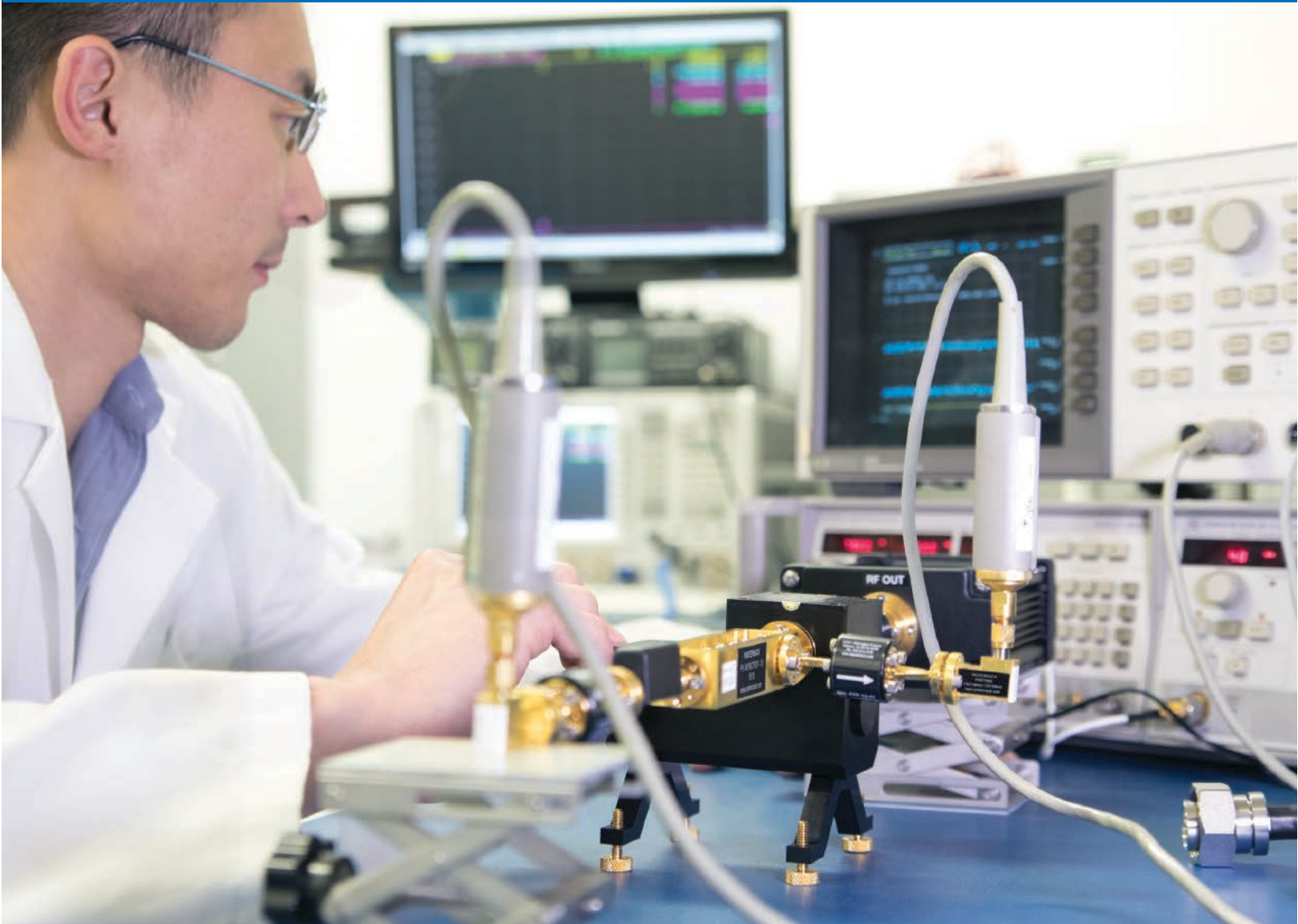

Largest Selection ✓ Same-Day Shipping ✓ Expert Technical Support ✓

866.727.8376 | sales@pasternack.com

PE PASTERNAK®
THE ENGINEER'S RF SOURCE

Connector Selection Guide

3 Easy Ways to Find your Product.....

1. Search by PE Part Number

If you know the PE part number you are searching for, please reference our Part Number Index on Page 245

2. Quick Reference Guide

(Page number refers to first appearance of product in the Connector Section)

Connector Series	Page	Connector Series	Page	Connector Series	Page	Connector Series	Page
1.0/2.3	116	75 Ohm MCX	158	HN	128	Rev. Pol. TNC	155
1.0mm	116	75 Ohm Mini SMB	158	LC	129	Reverse Thread SMA	145
1.85mm	116	75 Ohm N	158	MCX	129	SC	139
10-32	121	75 Ohm RCA	159	MHV	130	SHV	139
2.4mm	117	75 Ohm SMB	159	Mini SMP	131	SMA	142
2.92mm	118	75 Ohm SMC	160	Mini UHF	132	SMB	146
3.5mm	119	75 Ohm TNC	161	MMBX	133	SMC	147
3/4"-20 Twinax	162	BMA	122	MMCX	132	SMP	149
4.1/9.5 Mini DIN	119	BNC	124	N	135	SSMA	150
4.3-10	119	BNC Twinax	161	QMA	138	SSMB	151
7/16 DIN	120	C	126	QN	138	SSMC	151
75 Ohm 1.0/2.3	156	D-Sub	127	Rev. Pol. BNC	126	TNC	153
75 Ohm BNC	157	FAKRA	127	Rev. Pol. MCX	130	UHF	155
75 Ohm F	157	GR874	128	Rev. Pol. N	137	UMCX	156
				Rev. Pol. SMA	145		

Connectors

3. Connector Locator

Connector Type	Page
1.0/2.3 Jack Connectors	
Right Angle, PCB Mount	116
Straight, Bulkhead, Cable Connectors	116
Straight, Bulkhead, PCB Mount	116
Straight, PCB Mount	116
1.0/2.3 Plug Connectors	
Right Angle, Cable Connectors	116
Straight, Cable Connectors	116
1.0mm Female Connectors	
Straight, PCB Mount	116
1.85mm Female Connectors	
Straight, Bulkhead, Cable Connectors	117
Straight, Cable Connectors	116
Straight, PCB Mount	117
1.85mm Male Connectors	
Straight, Cable Connectors	116
10-32 Female Connectors	
Right Angle, PCB Mount	122
Straight, Bulkhead, Cable Connectors	121
Straight, Bulkhead, Terminal	121
Straight, Cable Connectors	121
Straight, PCB Mount	121
10-32 Male Connectors	

Connector Type	Page
Right Angle, Cable Connectors	121
Straight, Cable Connectors	121
2.4mm Female Connectors	
Straight, 2 Hole Flange, Terminal	117
Straight, 4 Hole Flange, Terminal	117
Straight, Bulkhead, Cable Connectors	117
Straight, PCB Mount	117
2.4mm Male Connectors	
Straight, Cable Connectors	117
Straight, PCB Mount	117
2.92mm Female Connectors	
Straight, 2 Hole Flange, Field Replaceable Contact	118
Straight, 4 Hole Flange, Field Replaceable Contact	118
Straight, Bulkhead, Cable Connectors	118
Straight, Cable Connectors	118
Straight, PCB Mount	118
Straight, Threaded, Field Replaceable Contact	118
2.92mm Male Connectors	
Straight, 2 Hole Flange, Terminal	118
Straight, Cable Connectors	117
Straight, PCB Mount	117
Straight, Threaded, Field Replaceable Contact	118
3.5mm Female Connectors	



Free Shipping Available
via UPS Ground
to USA & Canada



Technical Support
(866) 727-8376



Same-Day Shipping,
Even Custom
Cable Assemblies

Connector Locator

Connector Type	Page
Straight, Bulkhead, Cable Connectors	119
3.5mm Male Connectors	
Straight, Cable Connectors	118
4.1/9.5 Mini DIN Female Connectors	
Straight, Cable Connectors	119
4.1/9.5 Mini DIN Male Connectors	
Right Angle, Cable Connectors	119
Straight, Cable Connectors	119
4.3-10 Female Connectors	
Straight, 4 Hole Flange, Cable Connectors	120
Straight, 4 Hole Flange, Terminal	120
Straight, Cable Connectors	119
4.3-10 Male Connectors	
Right Angle, Cable Connectors	119
Straight, Cable Connectors	119
7/16 DIN Female Connectors	
Straight, 4 Hole Flange, Cable Connectors	121
Straight, 4 Hole Flange, Terminal	121
Straight, Bulkhead, Cable Connectors	121
Straight, Bulkhead, Terminal	121
Straight, Cable Connectors	120
7/16 DIN Male Connectors	
Right Angle, Cable Connectors	120
Straight, Cable Connectors	120
75 Ohm 1.0/2.3 Jack Connectors	
Right Angle, Bulkhead, PCB Mount	156
Straight, Bulkhead, PCB Mount	156
75 Ohm 1.0/2.3 Plug Connectors	
Straight, Cable Connectors	156
75 Ohm BNC Female Connectors	
Straight, 4 Hole Flange, Terminal	157
Straight, Bulkhead, Cable Connectors	157
Straight, Bulkhead, Terminal	157
Straight, Cable Connectors	157
75 Ohm BNC Male Connectors	
Right Angle, Cable Connectors	157
Straight, Cable Connectors	156
75 Ohm F Female Connectors	
Straight, Bulkhead, Cable Connectors	157
75 Ohm F Male Connectors	
Right Angle, Cable Connectors	157
Straight, Cable Connectors	157
75 Ohm MCX Plug Connectors	
Right Angle, Cable Connectors	158
Straight, Cable Connectors	158
75 Ohm Mini SMB Jack Connectors	
Straight, PCB Mount	158
75 Ohm Mini SMB Plug Connectors	
Right Angle, Cable Connectors	158
Straight, Cable Connectors	158
75 Ohm N Female Connectors	
Straight, 4 Hole Flange, Terminal	159

Connector Type	Page
Straight, Bulkhead, Terminal	159
Straight, Cable Connectors	158
75 Ohm N Male Connectors	
Right Angle, Cable Connectors	158
Straight, 4 Hole Flange, Terminal	158
Straight, Cable Connectors	158
75 Ohm RCA Female Connectors	
Straight, Bulkhead, Cable Connectors	159
75 Ohm RCA Male Connectors	
Straight, Cable Connectors	159
75 Ohm SMB Jack Connectors	
Right Angle, PCB Mount	159
Straight, PCB Mount	159
75 Ohm SMB Plug Connectors	
Straight, Bulkhead, Terminal	159
Straight, Cable Connectors	159
75 Ohm SMC Jack Connectors	
Right Angle, PCB Mount	160
Straight, Bulkhead, Cable Connectors	160
Straight, Bulkhead, Terminal	160
Straight, Cable Connectors	160
Straight, PCB Mount	160
75 Ohm SMC Plug Connectors	
Right Angle, Cable Connectors	160
Right Angle, PCB Mount	160
Straight, Cable Connectors	160
75 Ohm TNC Female Connectors	
Straight, Bulkhead, Cable Connectors	161
Straight, Bulkhead, Terminal	161
75 Ohm TNC Male Connectors	
Right Angle, Cable Connectors	160
Straight, Cable Connectors	160
78 Ohm BNC Twinax Jack Connectors	
Right Angle, PCB Mount	161
Straight, 4 Hole Flange, Terminal	161
Straight, Bulkhead, Cable Connectors	161
Straight, Bulkhead, Terminal	161
Straight, Cable Connectors	161
Straight, PCB Mount	161
78 Ohm BNC Twinax Plug Connectors	
Straight, Cable Connectors	161
95 Ohm 3/4"-20 Twinax Female Connectors	
Straight, 4 Hole Flange, Terminal	162
Straight, Bulkhead, Terminal	162
95 Ohm 3/4"-20 Twinax Male Connectors	
Straight, Cable Connectors	161
BMA Jack Connectors	
Right Angle, 2 Hole Flange, Cable Connectors	123
Straight, 2 Hole Flange, Cable Connectors	123
Straight, 2 Hole Flange, Terminal	123
Straight, 4 Hole Flange, Terminal	123

Connector Locator

Connector Type	Page
Straight, Bulkhead, Cable Connectors	123
Straight, Cable Connectors	122
Straight, PCB Mount	123
Straight, Terminal	123
Straight, Thread-In, Terminal	123
BMA Plug Connectors	
Right Angle, PCB Mount	122
Straight, 2 Hole Flange, Field Replaceable Contact	122
Straight, 2 Hole Flange, Terminal	122
Straight, 4 Hole Flange, Terminal	122
Straight, Bulkhead, Cable Connectors	122
Straight, PCB Mount	122
Straight, Thread-In, Terminal	122
BNC Female Connectors	
Right Angle, 4 Hole Flange, Terminal	125
Right Angle, Bulkhead, Terminal	125
Straight, 4 Hole Flange, Cable Connectors	125
Straight, 4 Hole Flange, Terminal	125
Straight, Bulkhead, Cable Connectors	125
Straight, Bulkhead, Terminal	125
Straight, Cable Connectors	124
BNC Male Connectors	
Right Angle, Cable Connectors	124
Straight, 4 Hole Flange, Terminal	124
Straight, Bulkhead, Terminal	124
Straight, Cable Connectors	123
C Female Connectors	
Straight, 4 Hole Flange, Cable Connectors	126
Straight, 4 Hole Flange, Terminal	127
Straight, Bulkhead, Cable Connectors	126
Straight, Bulkhead, Terminal	126
Straight, Cable Connectors	126
C Male Connectors	
Right Angle, Cable Connectors	126
Straight, 4 Hole Flange, Terminal	126
Straight, Cable Connectors	126
D-Sub Plug Connectors	
Right Angle, PCB Mount	127
Straight, Cable Connectors	127
D-Sub Receptacle Connectors	
Right Angle, Cable Connectors	127
Straight, Cable Connectors	127
FAKRA Jack Connectors	
Right Angle, Cable Connectors	127
Right Angle, PCB Mount	128
Straight, Cable Connectors	127
FAKRA Plug Connectors	
Right Angle, PCB Mount	127
Straight, Cable Connectors	127
Straight, PCB Mount	127
GR874 Sexless Connectors	

Connector Type	Page
Straight, Cable Connectors	128
HN Female Connectors	
Straight, 4 Hole Flange, Terminal	128
Straight, Bulkhead, Terminal	128
Straight, Cable Connectors	128
HN Male Connectors	
Right Angle, Cable Connectors	128
Straight, Cable Connectors	128
LC Female Connectors	
Straight, 4 Hole Flange, Terminal	129
Straight, Cable Connectors	129
LC Male Connectors	
Right Angle, Cable Connectors	129
Straight, Cable Connectors	129
MCX Jack Connectors	
Right Angle, PCB Mount	130
Straight, 2 Hole Flange, Terminal	130
Straight, Bulkhead, Cable Connectors	130
Straight, Bulkhead, Terminal	130
Straight, Cable Connectors	129
Straight, PCB Mount	129
MCX Plug Connectors	
Right Angle, Cable Connectors	129
Straight, Cable Connectors	129
Straight, PCB Mount	129
MHV Female Connectors	
Straight, 4 Hole Flange, Cable Connectors	131
Straight, 4 Hole Flange, Terminal	131
Straight, Bulkhead, Cable Connectors	131
Straight, Bulkhead, Terminal	131
Straight, Cable Connectors	130
MHV Male Connectors	
Right Angle, Cable Connectors	130
Straight, Cable Connectors	130
Mini SMP Female Connectors	
Right Angle, Cable Connectors	131
Straight, Cable Connectors	131
Mini SMP Male Connectors	
Right Angle, PCB Mount	131
Straight, PCB Mount	131
Mini UHF Female Connectors	
Straight, Bulkhead, Cable Connectors	132
Straight, Bulkhead, PCB Mount	132
Mini UHF Male Connectors	
Straight, Cable Connectors	131
MMBX Jack Connectors	
Straight, PCB Mount	133
Straight, Thread-In, Terminal	133
MMBX Plug Connectors	
Right Angle, Cable Connectors	133
Straight, Cable Connectors	132



Free Shipping Available
via UPS Ground
to USA & Canada



Technical
Support
(866) 727-8376



Same-Day Shipping,
Even Custom
Cable Assemblies

Connector Locator

Connector Type	Page
Straight, PCB Mount	132
MMCX Jack Connectors	
Right Angle, PCB Mount	132
Straight, PCB Mount	132
MMCX Plug Connectors	
Right Angle, Cable Connectors	132
Straight, Cable Connectors	132
Straight, PCB Mount	132
N Female Connectors	
Right Angle, 4 Hole Flange, Terminal	137
Right Angle, Bulkhead, PCB Mount	137
Straight, 2 Hole Flange, Terminal	136
Straight, 4 Hole Flange, Cable Connectors	136
Straight, 4 Hole Flange, Terminal	136
Straight, Bulkhead, Cable Connectors	135
Straight, Bulkhead, PCB Mount	136
Straight, Bulkhead, Terminal	136
Straight, Cable Connectors	135
Straight, PCB Mount	135
Straight, Press-In, Terminal	137
N Male Connectors	
Right Angle, Cable Connectors	134
Straight, 4 Hole Flange, Terminal	134
Straight, Bulkhead, Terminal	134
Straight, Cable Connectors	133
QMA Female Connectors	
Straight, Bulkhead, Cable Connectors	138
Straight, Cable Connectors	138
Straight, PCB Mount	138
QMA Male Connectors	
Right Angle, Cable Connectors	138
Straight, Cable Connectors	137
QN Female Connectors	
Straight, Bulkhead, Cable Connectors	138
QN Male Connectors	
Right Angle, Cable Connectors	138
Straight, Cable Connectors	138
Reverse Polarity BNC Female Connectors	
Straight, Bulkhead, Terminal	126
Reverse Polarity BNC Male Connectors	
Right Angle, Cable Connectors	125
Straight, Cable Connectors	125
Reverse Polarity MCX Jack Connectors	
Right Angle, Bulkhead, PCB Mount	130
Reverse Polarity MCX Plug Connectors	
Right Angle, Cable Connectors	130
Reverse Polarity N Male Connectors	
Straight, Cable Connectors	137
Reverse Polarity SMA Female Connectors	
Right Angle, Bulkhead, PCB Mount	145
Right Angle, PCB Mount	145

Connector Type	Page
Straight, 2 Hole Flange, Terminal	145
Straight, Bulkhead, Cable Connectors	145
Straight, Cable Connectors	145
Straight, PCB Mount	145
Reverse Polarity SMA Male Connectors	
Right Angle, Cable Connectors	144
Straight, Cable Connectors	144
Reverse Polarity TNC Female Connectors	
Straight, Bulkhead, Cable Connectors	155
Straight, Cable Connectors	155
Reverse Polarity TNC Male Connectors	
Right Angle, Cable Connectors	154
Straight, 4 Hole Flange, Terminal	154
Straight, Cable Connectors	154
Reverse Thread SMA Female Connectors	
Straight, Bulkhead, Cable Connectors	145
Straight, Cable Connectors	145
Straight, PCB Mount	145
Reverse Thread SMA Male Connectors	
Right Angle, Cable Connectors	145
Straight, Cable Connectors	145
SC Female Connectors	
Straight, 4 Hole Flange, Terminal	139
Straight, Bulkhead, Terminal	139
SC Male Connectors	
Right Angle, Cable Connectors	139
Straight, Cable Connectors	139
SHV Jack Connectors	
Straight, 4 Hole Flange, Terminal	139
Straight, Bulkhead, Cable Connectors	139
Straight, Bulkhead, Terminal	139
SHV Plug Connectors	
Straight, Bulkhead, Terminal	139
Straight, Cable Connectors	139
SMA Female Connectors	
Right Angle, 2 Hole Flange, Terminal	144
Right Angle, 4 Hole Flange, Field Replaceable Contact	144
Right Angle, 4 Hole Flange, Terminal	144
Right Angle, Bulkhead, PCB Mount	144
Right Angle, PCB Mount	144
Straight, 2 Hole Flange, Cable Connectors	143
Straight, 2 Hole Flange, Field Replaceable Contact	143
Straight, 2 Hole Flange, Terminal	143
Straight, 4 Hole Flange, Cable Connectors	143
Straight, 4 Hole Flange, Field Replaceable Contact	144
Straight, 4 Hole Flange, Terminal	143
Straight, Bulkhead, Cable Connectors	142
Straight, Bulkhead, PCB Mount	143
Straight, Bulkhead, Terminal	143
Straight, Cable Connectors	142
Straight, PCB Mount	142

Connector Locator

Connector Type	Page
Straight, Press-In, Terminal	144
SMA Male Connectors	
Right Angle, Cable Connectors	141
Right Angle, PCB Mount	141
Straight, 2 Hole Flange, Field Replaceable Contact	141
Straight, 2 Hole Flange, Terminal	141
Straight, 4 Hole Flange, Terminal	141
Straight, Bulkhead, Terminal	141
Straight, Cable Connectors	140
Straight, PCB Mount	140
SMB Jack Connectors	
Right Angle, Bulkhead, PCB Mount	147
Right Angle, PCB Mount	147
Straight, 4 Hole Flange, Terminal	147
Straight, Bulkhead, Cable Connectors	147
Straight, Bulkhead, PCB Mount	147
Straight, Bulkhead, Terminal	147
Straight, Cable Connectors	146
Straight, PCB Mount	146
SMB Plug Connectors	
Right Angle, Cable Connectors	146
Straight, Bulkhead, Terminal	146
Straight, Cable Connectors	146
Straight, PCB Mount	146
SMC Jack Connectors	
Right Angle, Bulkhead, PCB Mount	148
Right Angle, PCB Mount	148
Straight, 4 Hole Flange, Terminal	148
Straight, Bulkhead, Cable Connectors	147
Straight, Bulkhead, PCB Mount	148
Straight, Bulkhead, Terminal	148
Straight, Cable Connectors	147
Straight, PCB Mount	147
SMC Plug Connectors	
Right Angle, Cable Connectors	147
Right Angle, PCB Mount	147
Straight, Cable Connectors	147
SMP Female Connectors	
Right Angle, Cable Connectors	149
Straight, Cable Connectors	149
Straight, PCB Mount	149
SMP Male Connectors	
Right Angle, PCB Mount	149
Straight, 2 Hole Flange, Cable Connectors	148
Straight, Bulkhead, Cable Connectors	148
Straight, PCB Mount	148
Straight, Solder, Terminal	149
Straight, Terminal	148
Straight, Thread-In, Cable Connectors	148
Straight, Thread-In, Terminal	149
SSMA Female Connectors	
Right Angle, PCB Mount	150

Connector Type	Page
Straight, 2 Hole Flange, Cable Connectors	150
Straight, 2 Hole Flange, Terminal	150
Straight, 4 Hole Flange, Terminal	150
Straight, Bulkhead, Cable Connectors	150
Straight, Bulkhead, PCB Mount	150
Straight, Bulkhead, Terminal	150
Straight, Cable Connectors	150
Straight, PCB Mount	150
SSMA Male Connectors	
Right Angle, Cable Connectors	149
Straight, Cable Connectors	149
SSMB Jack Connectors	
Right Angle, PCB Mount	151
Straight, 4 Hole Flange, Terminal	151
Straight, Bulkhead, Cable Connectors	151
Straight, PCB Mount	151
SSMB Plug Connectors	
Right Angle, Cable Connectors	151
Straight, Cable Connectors	151
SSMC Jack Connectors	
Right Angle, Bulkhead, Cable Connectors	152
Right Angle, Bulkhead, Terminal	152
Right Angle, Cable Connectors	152
Right Angle, PCB Mount	152
Straight, 2 Hole Flange, Terminal	152
Straight, 4 Hole Flange, Terminal	152
Straight, Bulkhead, Cable Connectors	152
Straight, Bulkhead, Terminal	152
Straight, Cable Connectors	151
Straight, PCB Mount	152
SSMC Plug Connectors	
Right Angle, Cable Connectors	151
Right Angle, PCB Mount	151
Straight, Cable Connectors	151
TNC Female Connectors	
Right Angle, Bulkhead, Terminal	154
Straight, 4 Hole Flange, Terminal	154
Straight, Bulkhead, Cable Connectors	154
Straight, Bulkhead, Terminal	154
Straight, Cable Connectors	153
TNC Male Connectors	
Right Angle, Cable Connectors	153
Straight, 4 Hole Flange, Terminal	153
Straight, Cable Connectors	152
UHF Female Connectors	
Straight, 4 Hole Flange, Terminal	156
Straight, Bulkhead, Terminal	156
Straight, Cable Connectors	155
UHF Male Connectors	
Straight, Cable Connectors	155
UMCX Jack Connectors	
Straight, PCB Mount	156

Connectors



Free Shipping Available
via UPS Ground to
USA & Canada







Technical
Support
(866) 727-8376

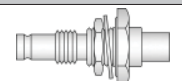

Same-Day Shipping,
Even Custom
Cable Assemblies

1.0/2.3 Connectors

Connection Method	Product Image	Attachment Cable/Contact	Coax Type / Termination Type	Model No.	Price				ROW
					1-24	25-49	50-99	100 +	
Plug									
Cable Connectors		Crimp/Solder	RG55, RG142, RG223, RG400	PE44242	\$10.99	\$10.22	\$9.45	\$8.79	1
			RG174, RG316, RG188, LMR-100, PE-B100, PE-C100, .100 inch	PE44244	\$12.61	\$11.73	\$10.84	\$10.09	2
Plug Right Angle									
Cable Connectors		Crimp/Solder	RG55, RG142, RG223, RG400	PE44247	\$13.66	\$12.70	\$11.75	\$10.93	3
			RG174, RG316, RG188, LMR-100, PE-B100, PE-C100, .100 inch	PE44249	\$14.24	\$13.24	\$12.25	\$11.39	4
Jack									
PCB Mount		Solder	Thru Hole with .200 inch x .055 inch Hole Spacing	PE44257	\$8.76	\$8.15	\$7.53	\$7.01	5
Jack, Bulkhead Mount									
Cable Connectors		Solder/Solder	PE-SR405AL, PE-SR405FL, RG405 with .235 inch D Hole	PE44256	\$16.57	\$15.41	\$14.25	\$13.26	6
PCB Mount		Solder	Thru Hole with .220 inch Diameter	PE44259	\$12.12	\$11.27	\$10.42	\$9.70	7
Jack Right Angle									
PCB Mount		Solder	Thru Hole with .200 inch x .055 inch Hole Spacing	PE44258	\$11.23	\$10.44	\$9.66	\$8.98	8

1.0mm Connectors

Connection Method	Product Image	Attachment Cable/Contact	Coax Type / Termination Type	Model No.	Price				ROW
					1-24	25-49	50-99	100 +	
Female									
PCB Mount		Clamp/Solder (Captive Contact)	End Launch	PE45403	\$1,038.27	\$965.59	\$892.91	\$830.62	9

1.6/5.6 Connectors, [See Web](#) (9 parts available)

1.85mm Connectors

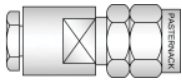
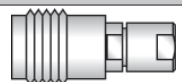
Connection Method	Product Image	Attachment Cable/Contact	Coax Type / Termination Type	Model No.	Price				ROW
					1-24	25-49	50-99	100 +	
Male									
Cable Connectors		Clamp/Solder	PE-047SR, PE-SR047AL, PE-SR047FL	PE44335	\$151.13	\$140.55	\$129.97	\$120.90	10
			PE-047SR, PE-047SRAL, PE-047SRFL	PE45410	\$89.31	\$83.06	\$76.81	\$71.45	11
			PE-SR405AL, RG405, PE-SR405FLJ	PE45413	\$89.31	\$83.06	\$76.81	\$71.45	12
Female									
Cable Connectors		Clamp/Solder	PE-047SR, PE-SR047AL, PE-SR047FL	PE44800	\$132.64	\$123.36	\$114.07	\$106.11	13

* Fits MIL-C-17 and equivalent cable versions only



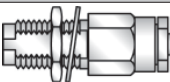

Connectors

See Our Website For Current Pricing & Real-Time Stock Availability!

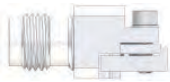

1.85mm Connectors

Connection Method	Product Image	Attachment Cable/Contact	Coax Type / Termination Type	Model No.	Price				ROW
					1-24	25-49	50-99	100 +	
PCB Mount		Clamp/Solder (Captive Contact)	End Launch	PE45402	\$228.05	\$212.09	\$196.12	\$182.44	14
			End Launch	PE45477	\$167.02	\$155.33	\$143.64	\$133.62	15
Cable Connectors	Female, Bulkhead Mount								
		Clamp/Solder	PE-SR405AL, PE-SR405FL, PE-SR405FLJ, PE-SR405TN, RG405 with .252 inch D Hole	PE44802	\$125.53	\$116.74	\$107.96	\$100.42	16

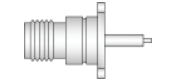
2.4mm Connectors

Connection Method	Product Image	Attachment Cable/Contact	Coax Type / Termination Type	Model No.	Price				ROW	
					1-24	25-49	50-99	100 +		
Male										
PCB Mount		Clamp	Vertical Launch	PE45456	\$45.82	\$42.61	\$39.41	\$36.66	17	
			Vertical Launch	PE45457	\$45.82	\$42.61	\$39.41	\$36.66	18	
Cable Connectors		Clamp/Solder	PE-SR405AL, PE-SR405FL, PE-SR405FLJ, PE-SR405TN, RG405	PE44345	\$82.14	\$76.39	\$70.64	\$65.71	19	
			Solder	PE-SR405AL, PE-SR405FL, RG405	PE44215	\$58.67	\$54.56	\$50.46	\$46.94	20
				PE-047SR, PE-047SRAL, PE-047SRFL	PE45411	\$81.87	\$76.14	\$70.41	\$65.50	21
			PE-SR405AL, RG405, PE-SR405FLJ	PE45414	\$81.87	\$76.14	\$70.41	\$65.50	22	
Female										
PCB Mount		Clamp	Vertical Launch	PE45454	\$42.83	\$39.83	\$36.83	\$34.26	23	
			Vertical Launch	PE45455	\$42.83	\$39.83	\$36.83	\$34.26	24	
		Clamp/Solder (Captive Contact)	End Launch	PE45401	\$169.85	\$157.96	\$146.07	\$135.88	25	
			End Launch	PE45472	\$90.98	\$84.61	\$78.24	\$72.78	26	
			End Launch	PE45473	\$90.98	\$84.61	\$78.24	\$72.78	27	
			End Launch	PE45474	\$90.98	\$84.61	\$78.24	\$72.78	28	
			End Launch	PE45475	\$90.98	\$84.61	\$78.24	\$72.78	29	
End Launch	PE45476	\$90.98	\$84.61	\$78.24	\$72.78	30				
Cable Connectors	Female, Bulkhead Mount									
		Clamp/Solder	PE-SR405AL, PE-SR405FL, PE-SR405FLJ, PE-SR405TN, RG405 with .252 inch D Hole	PE44801	\$132.64	\$123.36	\$114.07	\$106.11	31	
Female, 2 Hole Flange Mount										
Terminal		Solder	Pin with .481 inch Hole Spacing	PE44217	\$156.37	\$145.42	\$134.48	\$125.10	32	
Female, 4 Hole Flange Mount										
Terminal		Solder	Pin with .340 inch Hole Spacing	PE44218	\$132.09	\$122.84	\$113.60	\$105.67	33	
			Tab with .340 inch Hole Spacing	PE44226	\$117.86	\$109.61	\$101.36	\$94.29	34	

2.92mm Connectors

Connection Method	Product Image	Attachment Cable/Contact	Coax Type / Termination Type	Model No.	Price				ROW
					1-24	25-49	50-99	100 +	
Male									
PCB Mount		Clamp	Vertical Launch	PE45452	\$42.70	\$39.71	\$36.72	\$34.16	35
			Vertical Launch	PE45453	\$42.70	\$39.71	\$36.72	\$34.16	36
Cable Connectors		Clamp/Solder	PE-SR405AL, PE-SR405FL, PE-SR405FLJ, PE-SR405TN, RG405	PE44796	\$64.85	\$60.31	\$55.77	\$51.88	37
			PE-SR047FL, PE-SR047AL, PE-047SR	PE44797	\$107.22	\$99.71	\$92.21	\$85.78	38

* Fits MIL-C-17 and equivalent cable versions only



Free Shipping Available via UPS Ground to USA & Canada



Technical Support (866) 727-8376











Same-Day Shipping, Even Custom Cable Assemblies

Connectors

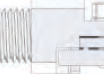
See Our Website For Current Pricing & Real-Time Stock Availability!

2.92mm Connectors

Connection Method	Product Image	Attachment Cable/Contact	Coax Type / Termination Type	Model No.	Price				ROW
					1-24	25-49	50-99	100 +	
Male									
Cable Connectors		Solder	PE-047SR, PE-047SRAL, PE-047SRFL	PE45412	\$74.44	\$69.23	\$64.02	\$59.55	39
			PE-SR405AL, RG405, PE-SR405FLJ	PE45415	\$74.44	\$69.23	\$64.02	\$59.55	40
			PE-SR402AL, PE-SR402FL, PE-SR402FLJ, PE-SR402TN, RG402	PE4987	\$45.75	\$42.55	\$39.35	\$36.60	41
			PE-SR405AL, PE-SR405FL, RG405	PE4988	\$46.93	\$43.64	\$40.36	\$37.54	42
			PE-118SR, .118 inch	PE4989	\$64.75	\$60.22	\$55.69	\$51.80	43
Male, 2 Hole Flange Mount									
Terminal		Solder	Pin with .354 inch Hole Spacing	PE44347	\$137.40	\$127.78	\$118.16	\$109.92	44
Male, Threaded Mount									
Field Replaceable		Field Replaceable	.012 inch Pin	PE44234	\$90.70	\$84.35	\$78.00	\$72.56	45
Female									
PCB Mount		Clamp	Vertical Launch	PE45450	\$39.90	\$37.11	\$34.31	\$31.92	46
			Vertical Launch	PE45451	\$39.90	\$37.11	\$34.31	\$31.92	47
Cable Connectors		Clamp/Solder	PE-SR405AL, PE-SR405FL, PE-SR405FLJ, PE-SR405TN, RG405	PE44228	\$111.24	\$103.45	\$95.67	\$88.99	48
			PE-047SR, PE-SR047AL, PE-SR047FL	PE44798	\$121.89	\$113.36	\$104.83	\$97.51	49
PCB Mount		Clamp/Solder (Captive Contact)	End Launch	PE45400	\$150.76	\$140.21	\$129.65	\$120.61	50
			End Launch	PE45467	\$67.34	\$62.63	\$57.91	\$53.87	51
			End Launch	PE45468	\$67.34	\$62.63	\$57.91	\$53.87	52
			End Launch	PE45469	\$67.34	\$62.63	\$57.91	\$53.87	53
			End Launch	PE45470	\$67.34	\$62.63	\$57.91	\$53.87	54
End Launch	PE45471	\$67.34	\$62.63	\$57.91	\$53.87	55			
Female, Bulkhead Mount									
Cable Connectors		Clamp/Solder	PE-SR405AL, PE-SR405FL, PE-SR405FLJ, PE-SR405TN, RG405 with .235 inch D Hole	PE4992	\$145.54	\$135.35	\$125.16	\$116.43	56
Female, 2 Hole Flange Mount									
Field Replaceable		Field Replaceable	.012 inch Pin with .481 inch Hole Spacing	PE44229	\$120.13	\$111.72	\$103.31	\$96.10	57
Female, 4 Hole Flange Mount									
Field Replaceable		Field Replaceable	.012 inch Pin with .340 inch Hole Spacing	PE44230	\$117.23	\$109.02	\$100.82	\$93.78	58
Female, Threaded Mount									
Field Replaceable		Field Replaceable	.012 inch Pin	PE44231	\$97.06	\$90.27	\$83.47	\$77.65	59

3.5mm Connectors

Connection Method	Product Image	Attachment Cable/Contact	Coax Type / Termination Type	Model No.	Price				ROW
					1-24	25-49	50-99	100 +	
Male									
Cable Connectors		Threaded	VNA Test Cable	PE44487	Call	Call	Call	Call	60
			PE-SR402AL, PE-SR402FL, PE-SR402FLJ, PE-SR402TN, RG402	PE4981	\$88.18	\$82.01	\$75.83	\$70.54	61
			PE-SR405AL, PE-SR405FL, PE-SR405FLJ, PE-SR405TN, RG405	PE4982	\$89.59	\$83.32	\$77.05	\$71.67	62

* Fits MIL-C-17 and equivalent cable versions only

Connectors



See Our Website For Current Pricing & Real-Time Stock Availability!

3.5mm Connectors







Connection Method	Product Image	Attachment Cable/Contact	Coax Type / Termination Type	Model No.	Price				ROW
					1-24	25-49	50-99	100 +	
Cable Connectors	Female, Bulkhead Mount								
		Clamp/Solder	PE-SR402AL, PE-SR402FL, RG402 with .235 inch D Hole	PE4985	\$262.57	\$244.19	\$225.81	\$210.06	63

3/4"-20 Twinax Connectors, [See Web](#) (4 parts available)

4.1/9.5 Mini DIN Connectors

Connection Method	Product Image	Attachment Cable/Contact	Coax Type / Termination Type	Model No.	Price				ROW
					1-24	25-49	50-99	100 +	
Cable Connectors	Male								
		Solder/Solder	SPP-250-LLPL	PE45421	\$27.80	\$25.85	\$23.91	\$22.24	64
Cable Connectors	Male Right Angle								
		Solder/Solder	SPP-250-LLPL	PE45422	\$38.22	\$35.54	\$32.87	\$30.58	65
Cable Connectors	Female								
		Solder/Solder	SPP-250-LLPL	PE45420	\$31.26	\$29.07	\$26.88	\$25.01	66

4.3-10 Connectors

Connection Method	Product Image	Attachment Cable/Contact	Coax Type / Termination Type	Model No.	Price				ROW
					1-24	25-49	50-99	100 +	
Cable Connectors	Male								
		Crimp/Solder	LMR-400	TC-400-4310M-X	Call	Call	Call	Call	67
			LMR-600	TC-600-4310M-X	Call	Call	Call	Call	68
		Clamp/Solder	RG213, RG8, RG225, RG214, RG393	PE45295	\$41.65	\$38.73	\$35.82	\$33.32	69
			RG213, RG8, RG225, RG214, RG393	PE45296	\$66.39	\$61.74	\$57.10	\$53.11	70
		Solder/Solder	PE-1/4SFHC	PE45297	\$39.36	\$36.60	\$33.85	\$31.49	71
			PE-1/4SFHC	PE45298	\$17.30	\$16.09	\$14.88	\$13.84	72
			PE-1/2SFHC	PE45299	\$17.54	\$16.31	\$15.08	\$14.03	73
			PE-1/2SFHC	PE45300	\$29.63	\$27.56	\$25.48	\$23.70	74
			RG402, PE-SR402AL, PE-SR402FL, PE-SR402FLJ	PE45301	\$29.15	\$27.11	\$25.07	\$23.32	75
			SPP-250-LLPL	PE45418	\$27.80	\$25.85	\$23.91	\$22.24	76
		Crimp/Non-Solder Contact	LMR-240	EZ-240-4310M-X	Call	Call	Call	Call	77
Male Right Angle									
Cable Connectors		Solder/Solder	PE-1/2SFHC	PE45302	\$45.68	\$42.48	\$39.28	\$36.54	78
			RG402, PE-SR402AL, PE-SR402FL, PE-SR402FLJ	PE45303	\$52.91	\$49.21	\$45.50	\$42.33	79
			SPP-250-LLPL	PE45419	\$38.22	\$35.54	\$32.87	\$30.58	80
Cable Connectors	Female								
		Solder/Solder	SPP-250-LLPL	PE45417	\$31.26	\$29.07	\$26.88	\$25.01	81

* Fits MIL-C-17 and equivalent cable versions only



Free Shipping Available via UPS Ground to USA & Canada



Technical Support (866) 727-8376





Same-Day Shipping, Even Custom Cable Assemblies





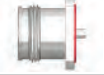

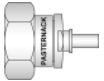

Connectors

See Our Website For Current Pricing & Real-Time Stock Availability!

4.3-10 Connectors

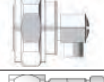
Connection Method	Product Image	Attachment Cable/Contact	Coax Type / Termination Type	Model No.	Price				ROW
					1-24	25-49	50-99	100 +	
Female, 4 Hole Flange Mount									
Cable Connectors		Solder/Solder	RG402, PE-SR402AL, PE-SR402FL, PE-SR402FLJ	PE45304	\$25.13	\$23.37	\$21.61	\$20.10	82
Terminal		Solder	Solder Cup	PE45306	\$18.52	\$17.22	\$15.93	\$14.82	83

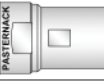
7/16 DIN Connectors







Connection Method	Product Image	Attachment Cable/Contact	Coax Type / Termination Type	Model No.	Price				ROW	
					1-24	25-49	50-99	100 +		
Male										
Cable Connectors		Crimp/Solder	PE-C195, PE-P195, RG58, RG141, RG303, LMR-195, .195 inch	PE44536	\$34.05	\$31.67	\$29.28	\$27.24	84	
			PE-C240, RG8X, .240 inch, LMR-240, LMR-240-DB, LMR-240-UF, B7808A	PE44994	\$41.84	\$38.91	\$35.98	\$33.47	85	
			RG55, RG141, RG142, RG223, RG400	PE4568	\$81.95	\$76.21	\$70.48	\$65.56	86	
			RG214, RG9, RG225, RG393	PE4571	\$50.29	\$46.77	\$43.25	\$40.23	87	
		Clamp/Solder	RG14, RG217	PE44276	\$136.18	\$126.65	\$117.11	\$108.94	88	
			RG17, RG218, RG219	PE44277	\$148.00	\$137.64	\$127.28	\$118.40	89	
			PE-SR401AL, PE-SR401FL, RG401	PE44278	\$40.12	\$37.31	\$34.50	\$32.10	90	
			RG393, RG214, RG225, RG215, RG8	PE4567	\$39.97	\$37.17	\$34.37	\$31.98	91	
		Solder/Solder	SPP-250-LLPL	PE45424	\$31.26	\$29.07	\$26.88	\$25.01	92	
			Clamp/Non-Solder Contact	1/2 inch Helical, 1/2 inch Superflexible, PE-1/2 Helical, PE-1/2SFHC	PE44732	\$40.51	\$37.67	\$34.84	\$32.41	93
				1/2 inch Flexible, PE-1/2FAC	PE44738	\$33.76	\$31.40	\$29.03	\$27.01	94
				Crimp/Non-Solder Contact	LMR-400, PE-C400, PE-B400, PE-B405	EZ-400-716M-X	\$30.06	\$30.06	\$30.06	\$30.06
LMR-600, PE-C600	EZ-600-716M-X	\$33.62			\$33.62	\$33.62	\$33.62	96		
PE-C400, PE-B400, PE-B405, LMR-400, LMR-400-DB, LMR-400-UF, .400 inch	PE44538	\$61.43			\$57.13	\$52.83	\$49.14	97		
Male Right Angle										
Cable Connectors		Clamp/Solder	RG213, RG214, RG8, RG9, RG225, RG393, RG215	PE44280	\$118.26	\$109.98	\$101.70	\$94.61	98	
			RG14, RG217	PE44282	\$197.72	\$183.88	\$170.04	\$158.18	99	
		Solder/Solder	SPP-250-LLPL	PE45425	\$45.15	\$41.99	\$38.83	\$36.12	1	
			Clamp/Non-Solder Contact	1/2 inch Helical	PE44979	\$33.08	\$30.76	\$28.45	\$26.46	2
Female										
Cable Connectors		Crimp/Solder	RG213, RG8	PE44284	\$111.84	\$104.01	\$96.18	\$89.47	3	
			RG214, RG9, RG225, RG393	PE4575	\$137.40	\$127.78	\$118.16	\$109.92	4	
		Clamp/Solder	RG213, RG55, RG141, RG142, RG223, RG400, RG303, PE-C195, PE-P195, LMR-195	PE44283	\$136.02	\$126.50	\$116.98	\$108.82	5	
			RG14, RG217	PE44288	\$135.90	\$126.39	\$116.87	\$108.72	6	
		Solder/Solder	SPP-250-LLPL	PE45423	\$31.26	\$29.07	\$26.88	\$25.01	7	

* Fits MIL-C-17 and equivalent cable versions only

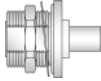
Connectors





See Our Website For Current Pricing & Real-Time Stock Availability!

7/16 DIN Connectors

Connection Method	Product Image	Attachment Cable/Contact	Coax Type / Termination Type	Model No.	Price				ROW
					1-24	25-49	50-99	100 +	
Female, Bulkhead Mount									
Cable Connectors		Crimp/Solder	.400 inch, LMR-400, LMR-400-DB, LMR-400-UF, PE-B405, PE-C400, PE-B400 with 1.161 inch DD Hole	PE44550	\$77.35	\$71.94	\$66.52	\$61.88	8
			PE-C600, LMR-600, LMR-600-DB, .600 inch with 1.161 inch DD Hole	PE44551	\$94.16	\$87.57	\$80.98	\$75.33	9
			RG55, RG142, RG223, RG400 with 1.161 inch DD Hole	PE44656	\$64.80	\$60.26	\$55.73	\$51.84	10
Terminal		Solder	Solder Cup	PE4572	\$164.73	\$153.20	\$141.67	\$131.78	11
Female, 4 Hole Flange Mount									
Cable Connectors		Clamp/Solder	RG214, RG213, RG393, RG8, RG225, RG215, RG9 with .975 inch Hole Spacing	PE44291	\$160.20	\$148.99	\$137.77	\$128.16	12
Terminal		Solder	Stub	PE45000	\$52.38	\$48.71	\$45.05	\$41.90	13
			Solder Cup with .975 inch Hole Spacing	PE4573	\$90.83	\$84.47	\$78.11	\$72.66	14
		Field Replaceable	Slotted Contact	PE44717	\$119.83	\$111.44	\$103.05	\$95.86	15
			Pin with .975 inch Hole Spacing	PE4574	\$84.94	\$78.99	\$73.05	\$67.95	16
		Threaded Pin	Pin with .975 inch Hole Spacing	PE4574A	\$33.38	\$31.04	\$28.71	\$26.70	17

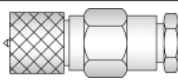
7mm Connectors, [See Web](#) (1 parts available)

10-32 Connectors

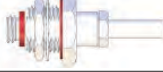
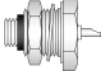
Connection Method	Product Image	Attachment Cable/Contact	Coax Type / Termination Type	Model No.	Price				ROW
					1-24	25-49	50-99	100 +	
Male									
Cable Connectors		Crimp/Solder	RG174, RG316, RG188, LMR-100, PE-B100, PE-C100, .100 inch	PE44351	\$21.52	\$20.01	\$18.51	\$17.22	18
			RG178, RG196	PE44352	\$33.61	\$31.26	\$28.90	\$26.89	19
			RG188-DS, RG316-DS	PE45170	\$21.75	\$20.23	\$18.71	\$17.40	20
		Clamp/Solder	RG174, RG316, RG188, PE-B100, PE-C100, .100 inch, LMR-100	PE44353	\$33.18	\$30.86	\$28.53	\$26.54	21
RG178, RG196			PE44354	\$32.57	\$30.29	\$28.01	\$26.06	22	
Male Right Angle									
Cable Connectors		Crimp/Solder	RG174, RG316, RG188, PE-B100, PE-C100, .100 inch, LMR-100	PE44355	\$24.86	\$23.12	\$21.38	\$19.89	23
			RG178, RG196	PE44356	\$36.56	\$34.00	\$31.44	\$29.25	24
			RG316-DS, RG188-DS	PE45032	\$23.15	\$21.53	\$19.91	\$18.52	25
Female									
Cable Connectors		Crimp/Solder	RG178, RG196	PE44362	\$26.31	\$24.47	\$22.63	\$21.05	26
PCB Mount		Solder	Thru Hole with .200 inch x .067 inch Hole Spacing	PE44359	\$22.69	\$21.10	\$19.51	\$18.15	27
Female, Bulkhead Mount									
Cable Connectors		Crimp/Solder	RG178, RG196 with .295 inch D Hole	PE44366	\$30.17	\$28.06	\$25.95	\$24.14	28
Terminal		Solder	Solder Cup with .177 inch D Hole	PE44357	\$24.11	\$22.42	\$20.73	\$19.29	29

* Fits MIL-C-17 and equivalent cable versions only



Free Shipping Available via UPS Ground to USA & Canada



Technical Support (866) 727-8376









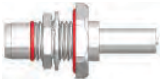

Same-Day Shipping, Even Custom Cable Assemblies

10-32 Connectors

Connection Method	Product Image	Attachment Cable/Contact	Coax Type / Termination Type	Model No.	Price				ROW
					1-24	25-49	50-99	100 +	
PCB Mount	Female Right Angle								
		Solder	Thru Hole with .200 inch x .067 inch Hole Spacing	PE44360	\$27.75	\$25.81	\$23.87	\$22.20	30

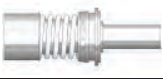
BMA Connectors







Connection Method	Product Image	Attachment Cable/Contact	Coax Type / Termination Type	Model No.	Price				ROW
					1-24	25-49	50-99	100 +	
PCB Mount	Plug								
		Solder	Thru Hole Thru Hole	PE45335 PE45336	\$58.77 \$31.59	\$54.66 \$29.38	\$50.54 \$27.17	\$47.02 \$25.27	31 32
Cable Connectors	Plug, Bulkhead Mount								
		Crimp/Solder	RG178, RG196	PE45315	\$73.70	\$68.54	\$63.38	\$58.96	33
			RG316, RG188, RG174, PE-C100, LMR-100A	PE45316	\$45.00	\$41.85	\$38.70	\$36.00	34
			RG188-DS, RG316-DS	PE45317	\$33.11	\$30.79	\$28.47	\$26.49	35
			RG142, RG223, RG400, RG55	PE45318	\$32.19	\$29.94	\$27.68	\$25.75	36
		Solder/Non-Solder Contact	RG405, PE-SR405AL, PE-SR405FL, PE-SR405FLJ, PE-SR405TN	PE45310	\$34.51	\$32.09	\$29.68	\$27.61	37
RG405, PE-SR405AL, PE-SR405FL, PE-SR405FLJ, PE-SR405TN			PE45311	\$23.83	\$22.16	\$20.49	\$19.06	38	
RG402, PE-SR402AL, PE-SR402FL, PE-SR402FLJ, PE-SR402TN			PE45313	\$54.57	\$50.75	\$46.93	\$43.66	39	
RG402, PE-SR402AL, PE-SR402FL, PE-SR402FLJ, PE-SR402TN	PE45314	\$22.99	\$21.38	\$19.77	\$18.39	40			
Terminal	Plug, 2 Hole Flange Mount								
		Solder	Stub with .481 inch Hole Spacing	PE45341	\$30.32	\$28.20	\$26.08	\$24.26	41
			Stub with .481 inch Hole Spacing	PE45342	\$33.53	\$31.18	\$28.84	\$26.82	42
			Stub with .481 inch Hole Spacing	PE45343	\$10.75	\$10.00	\$9.25	\$8.60	43
			Stub with .481 inch Hole Spacing	PE45344	\$15.04	\$13.99	\$12.93	\$12.03	44
Stub with .481 inch Hole Spacing			PE45347	\$64.46	\$59.95	\$55.44	\$51.57	45	
Field Replaceable		Field Replaceable	.012 inch Pin with .481 inch Hole Spacing	PE45345	\$217.85	\$202.60	\$187.35	\$174.28	46
			.020 inch Pin with .481 inch Hole Spacing	PE45346	\$208.05	\$193.49	\$178.92	\$166.44	47
			.036 inch Pin with .481 inch Hole Spacing	PE45348	\$68.31	\$63.53	\$58.75	\$54.65	48
Terminal	Plug, 4 Hole Flange Mount								
		Solder	Stub with .340 inch Hole Spacing	PE45339	\$34.04	\$31.66	\$29.27	\$27.23	49
Terminal	Plug, Thread-In								
		None	Pin	PE45350	\$100.90	\$93.84	\$86.77	\$80.72	50
			Pin	PE45351	\$60.63	\$56.39	\$52.14	\$48.50	51
			Pin	PE45352	\$115.25	\$107.18	\$99.12	\$92.20	52
Pin			PE45353	\$133.78	\$124.42	\$115.05	\$107.02	53	
PCB Mount	Plug Right Angle								
		Solder	Surface Mount Thru Hole	PE45333 PE45355	\$133.97 \$36.27	\$124.59 \$33.73	\$115.21 \$31.19	\$107.18 \$29.02	54 55
Cable Connectors	Jack								
		Crimp/Solder	RG316, RG188, RG174, PE-C100, LMR-100A	PE45319	\$73.81	\$68.64	\$63.48	\$59.05	56
			RG142, RG223, RG400, RG55	PE45320	\$98.08	\$91.21	\$84.35	\$78.46	57
		Solder/Solder	RG405, PE-SR405AL, PE-SR405FL, PE-SR405FLJ	PE45324	\$65.51	\$60.92	\$56.34	\$52.41	58
RG405, PE-SR405AL, PE-SR405FL, PE-SR405FLJ			PE45325	\$93.19	\$86.67	\$80.14	\$74.55	59	
	Solder/Non-Solder Contact	RG402, PE-SR402AL, PE-SR402FL, PE-SR402FLJ, PE-SR402TN	PE45328	\$76.04	\$70.72	\$65.39	\$60.83	60	

* Fits MIL-C-17 and equivalent cable versions only

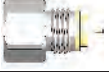
Connectors

See Our Website For Current Pricing & Real-Time Stock Availability!

BMA Connectors

Connection Method	Product Image	Attachment Cable/Contact	Coax Type / Termination Type	Model No.	Price				ROW
					1-24	25-49	50-99	100 +	
PCB Mount		Solder	Thru Hole	PE45337	\$48.95	\$45.52	\$42.10	\$39.16	61
			Surface Mount	PE45338	\$56.90	\$52.92	\$48.93	\$45.52	62
Terminal			Stub	PE45349	\$185.40	\$172.42	\$159.44	\$148.32	63
Jack, Bulkhead Mount									
Cable Connectors		Solder/Solder	RG405, PE-SR405AL, PE-SR405FL, PE-SR405FLJ	PE45323	\$42.10	\$39.15	\$36.21	\$33.68	64
Jack, 2 Hole Flange Mount									
Cable Connectors		Crimp/Solder	RG316, RG188, RG174, LMR-100A, PE-C100-LSZH	PE45321	\$40.76	\$37.91	\$35.05	\$32.61	65
		Solder/Solder	RG402, PE-SR402AL, PE-SR402FL, PE-SR402FLJ, PE-SR402TN	PE45326	\$54.51	\$50.69	\$46.88	\$43.61	66
			RG402, PE-SR402AL, PE-SR402FL, PE-SR402FLJ, PE-SR402TN	PE45327	\$36.47	\$33.92	\$31.36	\$29.18	67
		Solder/Non-Solder Contact	RG405, PE-SR405AL, PE-SR405FL, PE-SR405FLJ	PE45322	\$47.63	\$44.30	\$40.96	\$38.10	68
Terminal		Solder	Stub	PE45340	\$58.87	\$54.75	\$50.63	\$47.10	69
Jack, 4 Hole Flange Mount									
Terminal		Solder	Stub with .340 inch Hole Spacing	PE45334	\$52.20	\$48.55	\$44.89	\$41.76	70
Jack, Thread-In									
Terminal		None	Pin	PE45354	\$60.77	\$56.52	\$52.26	\$48.62	71
Jack Right Angle, 2 Hole Flange Mount									
Cable Connectors		Crimp/Solder	RG142, RG223, RG400, RG55	PE45332	\$53.47	\$49.73	\$45.98	\$42.78	72
		Solder/Solder	RG402, PE-SR402AL, PE-SR402FL, PE-SR402FLJ, PE-SR402TN	PE45329	\$64.43	\$59.92	\$55.41	\$51.54	73
			RG405, PE-SR405AL, PE-SR405FL, PE-SR405FLJ	PE45330	\$74.29	\$69.09	\$63.89	\$59.43	74
			RG405, PE-SR405AL, PE-SR405FL, PE-SR405FLJ	PE45331	\$59.08	\$54.94	\$50.81	\$47.26	75

BNC Connectors

Connection Method	Product Image	Attachment Cable/Contact	Coax Type / Termination Type	Model No.	Price				ROW		
					1-24	25-49	50-99	100 +			
Male											
Cable Connectors		Crimp/Crimp	RG58, RG303, RG141, PE-C195, PE-P195, LMR-195, .195 inch	PE4016	\$6.78	\$6.31	\$5.83	\$5.42	76		
			RG59*, RG62*, RG71	PE4018	\$8.23	\$7.65	\$7.08	\$6.58	77		
			.100 inch, RG316, RG174, RG188, LMR-100, LMR-100, LMR-100-FR, PE-C100, PE-B100	PE45045	\$7.03	\$6.54	\$6.05	\$5.62	78		
				Crimp/Solder	RG316-DS, RG188-DS	PE45114	\$6.77	\$6.30	\$5.82	\$5.42	79
					RG55, RG141, RG142, RG223, RG400	PE4044	\$7.30	\$6.79	\$6.28	\$5.84	80
					PE-B150, RG180, RG195	PE4247	\$12.57	\$11.69	\$10.81	\$10.06	81
					RG214, RG9, RG225, RG393	PE4351	\$21.24	\$19.75	\$18.27	\$16.99	82
					RG213, RG215, RG8	PE4378	\$23.64	\$21.99	\$20.33	\$18.91	83
					RG58 Plenum, RG122, RG58-P	PE4381	\$15.92	\$14.81	\$13.69	\$12.74	84
					RG59* Plenum, RG59*-P, RG302	PE4382	\$16.57	\$15.41	\$14.25	\$13.26	85
					PE-C400, LMR-400	PE44294	\$27.46	\$25.54	\$23.62	\$21.97	86
					PE-C240, RG8X, .240 inch, LMR-240, LMR-240-DB, LMR-240-UF, B7808A	PE44640	\$13.96	\$12.98	\$12.01	\$11.17	87

* Fits MIL-C-17 and equivalent cable versions only



Free Shipping Available via UPS Ground to USA & Canada



Technical Support (866) 727-8376









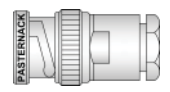
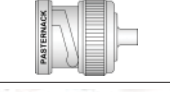

Same-Day Shipping, Even Custom Cable Assemblies

Connectors

See Our Website For Current Pricing & Real-Time Stock Availability!

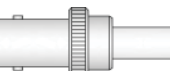
BNC Connectors







Connection Method	Product Image	Attachment Cable/Contact	Coax Type / Termination Type	Model No.	Price				ROW	
					1-24	25-49	50-99	100 +		
Cable Connectors	Male									
		Crimp/Solder	RG178, RG196	PE4643	\$22.12	\$20.57	\$19.02	\$17.70	88	
			LMR-200, PE-C200	TC-200-BM-X	\$14.27	\$14.27	\$14.27	\$14.27	89	
			LMR-240, PE-C240	TC-240-BM-X	\$12.51	\$12.51	\$12.51	\$12.51	90	
			LMR-400, PE-C400	TC-400-BM	\$13.87	\$13.87	\$13.87	\$13.87	91	
		Clamp/Solder	RG58, RG55, RG141, RG142, RG223, RG400, RG303, PE-C195, PE-P195, LMR-195	PE4023	\$6.89	\$6.41	\$5.93	\$5.51	92	
			RG59*, RG62*, RG71	PE4024	\$8.84	\$8.22	\$7.60	\$7.07	93	
			RG174, RG316, RG188, .100 inch, PE-B100, PE-C100, LMR-100	PE4084	\$12.07	\$11.23	\$10.38	\$9.66	94	
			RG8, RG215, RG225, RG214, RG393, RG213	PE4109	\$15.92	\$14.81	\$13.69	\$12.74	95	
			PE-SR402AL, PE-SR402FL, RG402	PE4206	\$18.63	\$17.33	\$16.02	\$14.90	96	
			RG8X, PE-C240, .240 inch, B7808A, LMR-240	PE4379	\$17.31	\$16.10	\$14.89	\$13.85	97	
			RG178, RG196	PE4384	\$15.72	\$14.62	\$13.52	\$12.58	98	
			PE-B400, PE-B405, PE-C400, LMR-400, .400 inch	PE4386	\$26.16	\$24.33	\$22.50	\$20.93	99	
			LMR-240, PE-C240	TC-240-BMC	\$16.68	\$16.68	\$16.68	\$16.68	1	
				Solder/Solder	PE-SR402AL, PE-SR402FL, PE-SR402FLJ, PE-SR402TN, RG402	PE4650	\$24.11	\$22.42	\$20.73	\$19.29
	PE-SR405AL, PE-SR405FL, RG405	PE4651			\$24.11	\$22.42	\$20.73	\$19.29	3	
	PE-047SR, PE-SR047AL, PE-SR047FL	PE4974			\$34.43	\$32.02	\$29.61	\$27.54	4	
		Crimp/Non-Solder Contact	LMR-400, PE-C400, LMR-400-DB	EZ-400-BM-X	\$27.42	\$27.42	\$27.42	\$27.42	5	
	Terminal	Male, Bulkhead Mount								
			Solder	Solder Cup with .350 inch D Hole	PE4211	\$14.43	\$13.42	\$12.41	\$11.54	6
Terminal	Male, 4 Hole Flange Mount									
		Solder	Solder Cup with .531 inch Hole Spacing	PE4082	\$15.68	\$14.58	\$13.48	\$12.54	7	
Cable Connectors	Male Right Angle									
		Crimp/Crimp	RG58, RG303, RG141, PE-C195, PE-P195, LMR-195, .195 inch	PE4298	\$24.67	\$22.94	\$21.22	\$19.74	8	
			RG55, RG141, RG142, RG223, RG400	PE4345	\$10.95	\$10.18	\$9.42	\$8.76	9	
		Crimp/Solder	RG174, RG316, RG188, .100 inch, PE-B100, PE-C100, LMR-100	PE4393	\$24.20	\$22.51	\$20.81	\$19.36	10	
			PE-C240, RG8X, .240 inch, LMR-240, LMR-240-DB, LMR-240-UF, B7808A	PE44641	\$24.76	\$23.03	\$21.29	\$19.81	11	
		Clamp/Solder	RG58, RG55, RG141, RG142, RG223, RG400, RG303, PE-C195, PE-P195, LMR-195	PE4053	\$17.61	\$16.38	\$15.14	\$14.09	12	
RG174, RG316, RG188, .100 inch, PE-B100, PE-C100, LMR-100			PE4307	\$49.52	\$46.05	\$42.59	\$39.62	13		
RG213, RG214, RG8, RG9, RG11*, RG225, RG393, RG144*, RG216*, RG215			PE4387	\$33.53	\$31.18	\$28.84	\$26.82	14		
RG178, RG196	PE4388	\$21.77	\$20.25	\$18.72	\$17.42	15				
Cable Connectors	Female									
		Crimp/Solder	PE-C195, PE-P195, RG58, RG141, RG303, LMR-195, .195 inch	PE4070	\$8.91	\$8.29	\$7.66	\$7.13	16	
			RG174, RG316, RG188, LMR-100, PE-B100, PE-C100, .100 inch	PE4079	\$13.88	\$12.91	\$11.94	\$11.10	17	
			RG55, RG141, RG142, RG223, RG400	PE4397	\$9.59	\$8.92	\$8.25	\$7.67	18	
			PE-C240, RG8X, .240 inch, LMR-240, LMR-240-DB, LMR-240-UF, B7808A	PE44642	\$8.06	\$7.50	\$6.93	\$6.45	19	
		Clamp/Solder	RG58, RG55, RG141, RG142, RG223, RG400, RG303, PE-C195, PE-P195, LMR-195	PE4058	\$9.34	\$8.69	\$8.03	\$7.47	20	
			RG213, RG214, RG8, RG9, RG11*, RG225, RG393, RG144*, RG216*, RG215	PE4212	\$41.43	\$38.53	\$35.63	\$33.14	21	
			RG174, RG316, RG188	PE4321	\$12.86	\$11.96	\$11.06	\$10.29	22	
RG178, RG196			PE4389	\$17.42	\$16.20	\$14.98	\$13.94	23		

* Fits MIL-C-17 and equivalent cable versions only

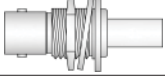
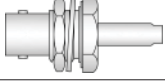
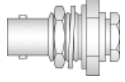
Connectors

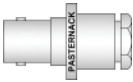
See Our Website For Current Pricing & Real-Time Stock Availability!





BNC Connectors

Connection Method	Product Image	Attachment Cable/Contact	Coax Type / Termination Type	Model No.	Price				ROW
					1-24	25-49	50-99	100 +	
Female, Bulkhead Mount									
Cable Connectors		Crimp/Crimp	RG58, PE-C195, PE-P195, LMR-195	PE45064	\$11.27	\$10.48	\$9.69	\$9.02	24
		Crimp/Solder	RG174, RG316, RG188, LMR-100, PE-B100, PE-C100, .100 inch with .480 inch D Hole	PE4106	\$15.54	\$14.45	\$13.36	\$12.43	25
			RG55, RG142, RG223, RG400, RG141 with .480 inch D Hole	PE4209	\$18.53	\$17.23	\$15.94	\$14.82	26
			RG188-DS, RG316-DS with .480 inch D Hole	PE4392	\$17.42	\$16.20	\$14.98	\$13.94	27
		Clamp/Solder	RG58, RG142, RG223, RG400, RG141, RG303, RG55, LMR-400, PE-C195, PE-P195 with .480 inch D Hole	PE4078	\$16.37	\$15.22	\$14.08	\$13.10	28
			RG174, RG316, RG188 with .480 inch D Hole	PE4319	\$15.72	\$14.62	\$13.52	\$12.58	29
			RG178, RG196 with .480 inch D Hole	PE4391	\$18.93	\$17.60	\$16.28	\$15.14	30
			RG214, RG213, RG393, RG8, RG225, RG11*, RG216*, RG144*, RG215, RG9 with .480 inch D Hole	PE4632	\$45.99	\$42.77	\$39.55	\$36.79	31
			PE-SR402AL, PE-SR402FL, RG402	PE4915	\$30.57	\$28.43	\$26.29	\$24.46	32
	Terminal		Solder	Solder Cup with .410 inch D Hole	PE4014	\$6.59	\$6.13	\$5.67	\$5.27
Solder Cup with .350 inch D Hole				PE4015	\$6.13	\$5.70	\$5.27	\$4.90	34
Turret with .480 inch D Hole				PE4049	\$16.43	\$15.28	\$14.13	\$13.14	35
Spade with .350 inch D Hole				PE4077	\$16.61	\$15.45	\$14.28	\$13.29	36
Solder Cup with .350 inch D Hole				PE4091	\$8.87	\$8.25	\$7.63	\$7.10	37
Solder Cup with .480 inch D Hole				PE4318	\$16.00	\$14.88	\$13.76	\$12.80	38
Eyelet				PE44890	\$26.38	\$24.53	\$22.69	\$21.10	39
Female, 4 Hole Flange Mount									
Cable Connectors		Clamp/Solder	RG58, RG142, RG223, RG400, RG141, RG303, RG55 LMR-400, PE-C195, PE-P195 with .500 inch Threaded Hole Spacing	PE4056	\$16.31	\$15.17	\$14.03	\$13.05	40
Terminal		Solder	Solder Cup with .500 inch Threaded Hole Spacing	PE4010	\$8.71	\$8.10	\$7.49	\$6.97	41
			Turret with .531 inch Hole Spacing	PE4011	\$18.66	\$17.35	\$16.05	\$14.93	42
Female Right Angle, Bulkhead Mount									
Terminal		Solder	Solder Cup with .361 inch D Hole	PE4055	\$24.50	\$22.79	\$21.07	\$19.60	43
Female Right Angle, 4 Hole Flange Mount									
Terminal		Solder	Solder Cup with .531 inch Hole Spacing	PE4317	\$28.67	\$26.66	\$24.66	\$22.94	44

Connectors

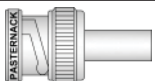
See Our Website For Current Pricing & Real-Time Stock Availability!

Reverse Polarity BNC Connectors

Connection Method	Product Image	Attachment Cable/Contact	Coax Type / Termination Type	Model No.	Price				ROW
					1-24	25-49	50-99	100 +	
Male									
Cable Connectors		Crimp/Solder	RG55, RG141, RG142, RG223, RG400	PE4715	\$13.78	\$12.82	\$11.85	\$11.02	45
			RG59*, RG62*	PE4718	\$15.06	\$14.01	\$12.95	\$12.05	46
			RG174, RG316, RG188, LMR-100, PE-B100, PE-C100, .100 inch	PE4720	\$22.56	\$20.98	\$19.40	\$18.05	47
		Clamp/Solder	RG58, RG55, RG141, RG142, RG223, RG400, RG303, PE-C195, PE-P195, LMR-195	PE4714	\$32.29	\$30.03	\$27.77	\$25.83	48
Male Right Angle									
Cable Connectors		Crimp/Solder	RG58, RG303, RG141, PE-C195, PE-P195, LMR-195, .195 inch	PE4730	\$27.69	\$25.75	\$23.81	\$22.15	49
			RG174, RG316, RG188	PE4733	\$22.56	\$20.98	\$19.40	\$18.05	50
			Clamp/Solder	RG58, RG55, RG141, RG142, RG223, RG400, RG303, PE-C195, PE-P195, LMR-195	PE4728	\$23.30	\$21.67	\$20.04	\$18.64

* Fits MIL-C-17 and equivalent cable versions only



Free Shipping Available via UPS Ground to USA & Canada



Technical Support (866) 727-8376







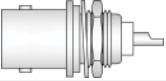

Same-Day Shipping, Even Custom Cable Assemblies

Reverse Polarity BNC Connectors

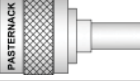
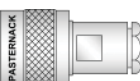
Connection Method	Product Image	Attachment Cable/Contact	Coax Type / Termination Type	Model No.	Price				ROW
					1-24	25-49	50-99	100 +	
Female, Bulkhead Mount									
Terminal		Solder	Solder Cup with .410 inch D Hole	PE4757	\$15.50	\$14.42	\$13.33	\$12.40	52
			Solder Cup with .480 inch D Hole	PE4764	\$20.83	\$19.37	\$17.91	\$16.66	53

Banana Connectors, [See Web](#) (2 parts available)

C Connectors

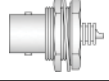
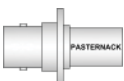
Connection Method	Product Image	Attachment Cable/Contact	Coax Type / Termination Type	Model No.	Price				ROW
					1-24	25-49	50-99	100 +	
Male									
Cable Connectors		Crimp/Solder	RG214, RG9, RG225, RG393	PE4375	\$27.18	\$25.28	\$23.37	\$21.74	54
			RG55, RG141, RG142, RG223, RG400	PE4445	\$26.52	\$24.66	\$22.81	\$21.22	55
			RG58, RG303, RG141, PE-C195, PE-P195, LMR-195, .195 inch	PE4517	\$34.30	\$31.90	\$29.50	\$27.44	56
		Clamp/Solder	RG55, RG58, RG141, RG142, RG223, RG303, RG400, PE-C195, PE-P195, LMR-195	PE4242	\$44.90	\$41.76	\$38.61	\$35.92	57
			RG213, RG214, RG8, RG9, RG11*, RG225, RG393, RG144*, RG216*, RG215	PE4243	\$39.11	\$36.37	\$33.63	\$31.29	58
			RG213, RG214, RG8, RG9, RG11*, RG225, RG393, RG144*, RG216*, RG215	PE4950	\$43.69	\$40.63	\$37.57	\$34.95	59
RG14, RG217			PE4951	\$53.15	\$49.43	\$45.71	\$42.52	60	
		RG59*, RG62*, RG71	PE4952	\$39.78	\$37.00	\$34.21	\$31.82	61	
Male, 4 Hole Flange Mount									
Terminal		Solder	Solder Cup with .718 inch Hole Spacing	PE44096	\$60.00	\$55.80	\$51.60	\$48.00	62
Male Right Angle									
Cable Connectors		Crimp/Solder	RG214, RG9, RG225, RG393	PE4949	\$76.44	\$71.09	\$65.74	\$61.15	63
			RG55, RG141, RG142, RG223, RG400	PE4958	\$62.07	\$57.73	\$53.38	\$49.66	64
		Clamp/Solder	PE-P195, PE-C195, RG58, RG141, RG303, .195 inch, LMR-195	PE4959	\$78.24	\$72.76	\$67.29	\$62.59	65
			RG213, RG214, RG8, RG9, RG11*, RG225, RG393, RG144*, RG216*, RG215	PE4244	\$65.87	\$61.26	\$56.65	\$52.70	66
		RG55, RG58, RG141, RG142, RG223, RG303, RG400, PE-C195, PE-P195, LMR-195	PE4957	\$81.89	\$76.16	\$70.43	\$65.51	67	
Female									
Cable Connectors		Clamp/Solder	RG213, RG214, RG8, RG9, RG11*, RG225, RG393, RG144*, RG216*, RG215	PE4960	\$53.52	\$49.77	\$46.03	\$42.82	68
			RG55, RG58, RG141, RG142, RG223, RG303, RG400, PE-C195, PE-P195, LMR-195	PE4961	\$72.69	\$67.60	\$62.51	\$58.15	69
Female, Bulkhead Mount									
Cable Connectors		Clamp/Solder	RG58, RG142, RG223, RG400, RG141, RG303, RG55, LMR-400, PE-C195, PE-P195 with .596 inch D Hole	PE44099	\$64.15	\$59.66	\$55.17	\$51.17	70
			RG214, RG213, RG393, RG8, RG225, RG11*, RG216*, RG144*, RG215, RG9 with .720 inch D Hole	PE4964	\$60.88	\$56.62	\$52.36	\$48.70	71
Terminal		Solder	Solder Cup with .720 inch D Hole	PE4240	\$48.94	\$45.51	\$42.09	Call	72
			Turret with .350 inch D Hole	PE4973	\$72.02	\$66.98	\$61.94	\$57.62	73
Female, 4 Hole Flange Mount									
Cable Connectors		Crimp/Solder	RG214, RG9, RG225, RG393 with .718 inch Hole Spacing	PE4374	\$60.51	\$56.27	\$52.04	\$48.41	74
			RG214, RG213, RG393, RG8, RG225, RG11*, RG216*, RG144*, RG215, RG9 with .718 inch Hole Spacing	PE4967	\$72.69	\$67.60	\$62.51	\$58.15	75
			RG58, RG142, RG223, RG400, RG141, RG303, RG55, LMR-400, PE-C195, PE-P195 with .718 inch Hole Spacing	PE4969	\$52.89	\$49.19	\$45.49	\$42.31	76

* Fits MIL-C-17 and equivalent cable versions only





Connectors

See Our Website For Current Pricing & Real-Time Stock Availability!

C Connectors





Connection Method	Product Image	Attachment Cable/Contact	Coax Type / Termination Type	Model No.	Price				ROW
					1-24	25-49	50-99	100 +	
Terminal		Solder	Solder Cup with .718 inch Hole Spacing	PE4241	\$21.25	\$19.76	\$18.28	\$17.00	77
			Solder Cup with .718 inch Hole Spacing	PE44117	\$33.53	\$31.18	\$28.84	\$26.82	78

D-Sub Connectors

Connection Method	Product Image	Attachment Cable/Contact	Coax Type / Termination Type	Model No.	Price				ROW
					1-24	25-49	50-99	100 +	
Plug									
Cable Connectors		Crimp/Solder	RG174, RG316, RG188, .100 inch, PE-B100, PE-C100, LMR-100	PE4809	\$18.04	\$16.78	\$15.51	\$14.43	79
			RG55, RG142, RG223, RG400	PE4842	\$14.21	\$13.22	\$12.22	\$11.37	80
		Solder/Solder	RG174, RG316, RG187, RG188	PE4813	\$13.72	\$12.76	\$11.80	\$10.98	81
			RG180, RG195, PE-B150	PE4815	\$18.31	\$17.03	\$15.75	\$14.65	82
Plug Right Angle									
PCB Mount		Solder	Thru Hole with .200 inch x .046 inch Hole Spacing	PE4835	\$21.58	\$20.07	\$18.56	\$17.26	83
Receptacle									
Cable Connectors		Crimp/Solder	RG174, RG316, RG188, .100 inch, PE-B100, PE-C100, LMR-100	PE4801	\$15.48	\$14.40	\$13.31	\$12.38	84
			RG55, RG142, RG223, RG400	PE4837	\$11.65	\$10.83	\$10.02	\$9.32	85
Receptacle Right Angle									
Cable Connectors		Crimp/Solder	RG58, RG141, RG303	PE4816	\$19.75	\$18.37	\$16.99	\$15.80	86
		Solder/Solder	RG58, RG141, RG303	PE4820	\$12.28	\$11.42	\$10.56	\$9.82	87
			PE-SR402AL, PE-SR402FL, RG402	PE4849	\$24.43	\$22.72	\$21.01	\$19.54	88

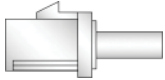
F Connectors, [See Web](#) (28 parts available)

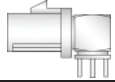
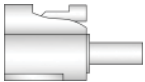
FAKRA Connectors

Connection Method	Product Image	Attachment Cable/Contact	Coax Type / Termination Type	Model No.	Price				ROW
					1-24	25-49	50-99	100 +	
Plug									
Cable Connectors		Crimp/Solder	RG174, RG316, RG188, .100 inch, PE-B100, PE-C100, LMR-100 with Violet Color	PE45404H	\$5.18	\$4.82	\$4.45	\$4.14	89
			RG174, RG316, RG188, .100 inch, PE-B100, PE-C100, LMR-100 with Water Blue Color	PE45404Z	\$5.18	\$4.82	\$4.45	\$4.14	90
PCB Mount		Solder	Thru Hole with Black Color	PE44649A	\$5.18	\$4.82	\$4.45	\$4.14	91
			Thru Hole with Water Blue Color	PE44649Z	\$5.60	\$5.21	\$4.82	\$4.48	92
Plug Right Angle									
PCB Mount		Solder	Thru Hole with Black Color	PE44651A	\$7.26	\$6.75	\$6.24	\$5.81	93
			Thru Hole with Blue Color	PE44651C	\$7.26	\$6.75	\$6.24	\$5.81	94
			Thru Hole with Water Blue Color	PE44651Z	\$7.00	\$6.51	\$6.02	\$5.60	95
Jack									
Cable Connectors		Crimp/Solder	RG174, RG316, RG188, .100 inch, PE-B100, PE-C100, LMR-100 with Black Color	PE44646A	\$5.97	\$5.55	\$5.13	\$4.78	96
			RG174, RG316, RG188, .100 inch, PE-B100, PE-C100, LMR-100 with Blue Color	PE44646C	\$5.97	\$5.55	\$5.13	\$4.78	97
			RG174, RG316, RG188, .100 inch, PE-B100, PE-C100, LMR-100 with Water Blue Color	PE44646Z	\$5.70	\$5.30	\$4.90	\$4.56	98
Jack Right Angle									
Cable Connectors		Crimp/Solder	RG174, RG316, RG188, .100 inch, PE-B100, PE-C100, LMR-100 with Water Blue Color	PE44648Z	\$7.13	\$6.63	\$6.13	\$5.70	99

* Fits MIL-C-17 and equivalent cable versions only



Free Shipping Available via UPS Ground to USA & Canada



Technical Support (866) 727-8376



Same-Day Shipping, Even Custom Cable Assemblies

Connectors

See Our Website For Current Pricing & Real-Time Stock Availability!

FAKRA Connectors

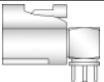





Connection Method	Product Image	Attachment Cable/Contact	Coax Type / Termination Type	Model No.	Price				ROW
					1-24	25-49	50-99	100 +	
PCB Mount		Solder	Thru Hole with Water Blue Color	PE44650Z	\$7.72	\$7.18	\$6.64	\$6.18	1

FME Connectors, [See Web](#) (7 parts available)

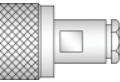
GR874 Connectors

Connection Method	Product Image	Attachment Cable/Contact	Coax Type / Termination Type	Model No.	Price				ROW
					1-24	25-49	50-99	100 +	
Cable Connectors	Sexless								
		Accessories		PE4348	\$42.58	\$39.60	\$36.62	\$34.06	2

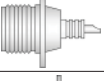

HN Connectors

Connection Method	Product Image	Attachment Cable/Contact	Coax Type / Termination Type	Model No.	Price				ROW	
					1-24	25-49	50-99	100 +		
Cable Connectors	Male									
		Crimp/Solder	RG213, RG215, RG8	PE4473	\$37.84	\$35.19	\$32.54	\$30.27	3	
			RG214, RG9, RG225, RG393	PE4474	\$41.15	\$38.27	\$35.39	\$32.92	4	
			RG55, RG142, RG223, RG400, RG141	PE4477	\$34.97	\$32.52	\$30.07	\$27.98	5	
			RG58, RG141	PE4478	\$30.57	\$28.43	\$26.29	\$24.46	6	
		Clamp/Solder	RG213, RG214, RG8, RG9, RG225, RG393	PE4182	\$25.96	\$24.14	\$22.33	\$20.77	7	
			RG58, RG55, RG141, RG142, RG223, RG400, RG303, PE-C195, PE-P195, LMR-195	PE4198	\$33.21	\$30.89	\$28.56	\$26.57	8	
			RG14, RG217	PE4475	\$44.39	\$41.28	\$38.18	\$35.51	9	
			RG59*, RG62*, RG71	PE4479	\$47.37	\$44.05	\$40.74	\$37.90	10	
				Clamp/Solder	RG213, RG8, RG393, RG225, RG214, RG393, RG9	PE4230	\$58.99	\$54.86	\$50.73	\$47.19
RG55, RG58, RG141, RG142, RG223, RG303, RG400, PE-C195, PE-P195, LMR-195					PE4480	\$67.16	\$62.46	\$57.76	\$53.73	12
RG14, RG217	PE4530Z	\$68.57			\$63.77	\$58.97	\$54.86	13		
Cable Connectors		Clamp/Solder	RG213, RG8, RG225, RG214, RG393	PE4229	\$52.20	\$48.55	\$44.89	\$41.76	14	
Terminal		Solder	Turret with .765 inch DD Hole	PE4481	\$57.30	\$53.29	\$49.28	\$45.84	15	
Terminal	Female, 4 Hole Flange Mount									
		Solder	Solder Cup with .906 inch Hole Spacing	PE4183	\$28.56	\$26.56	\$24.56	\$22.85	16	
Terminal		Field Replaceable	Slotted Contact	PE44718	\$56.56	\$52.60	\$48.64	\$45.25	17	

PasterFact™:
Electromagnetic waves always travel at the same speed (299,792 km per second).



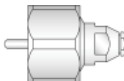
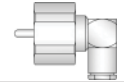

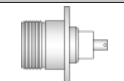

* Fits MIL-C-17 and equivalent cable versions only

LC Connectors

Connection Method	Product Image	Attachment Cable/Contact	Coax Type / Termination Type	Model No.	Price				ROW
					1-24	25-49	50-99	100 +	
Male									
Cable Connectors		Clamp/Solder	RG218, RG219, RG17	PE4323	\$196.59	\$182.83	\$169.07	\$157.27	18
			RG14, RG217	PE4563	\$175.94	\$163.62	\$151.31	\$140.75	19
			RG213, RG214, RG8, RG9, RG225, RG393, RG215	PE4564	\$147.30	\$136.99	\$126.68	\$117.84	20
			RG55, RG58, RG141, RG142, RG223, RG303, RG400, PE-C195, PE-P195, LMR-195	PE4565	\$129.28	\$120.23	\$111.18	\$103.42	21
Male Right Angle									
Cable Connectors		Clamp/Solder	RG213, RG214, RG8, RG9, RG225, RG393, RG215	PE44447	\$226.48	\$210.63	\$194.77	\$181.18	22
Female									
Cable Connectors		Clamp/Solder	RG17, RG218, RG219	PE44451	\$242.35	\$225.39	\$208.42	\$193.88	23
Female, 4 Hole Flange Mount									
Terminal		Solder	Pin with 1.44 inch Hole Spacing	PE4192	\$101.09	\$94.01	\$86.94	\$80.87	24

MC-Card Connectors, [See Web](#) (6 parts available)

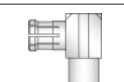
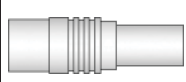
MCX Connectors

Connection Method	Product Image	Attachment Cable/Contact	Coax Type / Termination Type	Model No.	Price				ROW
					1-24	25-49	50-99	100 +	
Plug									
Cable Connectors		Crimp/Solder	RG316, RG174, RG188, LMR-100, PE-B100, PE-C100, .100 inch	PE4551	\$13.00	\$12.09	\$11.18	\$10.40	25
			RG178, RG196	PE4552	\$16.99	\$15.80	\$14.61	\$13.59	26
			RG188-DS, RG316-DS	PE4878	\$11.65	\$10.83	\$10.02	\$9.32	27
			RG55, RG141, RG142, RG223, RG400	PE4881	\$24.60	\$22.88	\$21.16	\$19.68	28
PCB Mount		Solder	Surface Mount	PE44613	\$14.35	\$13.35	\$12.34	\$11.48	29
	Thru Hole with .200 inch x .052 inch Hole Spacing		PE4559	\$18.74	\$17.43	\$16.12	\$14.99	30	
Cable Connectors			PE-SR405AL, PE-SR405FL, PE-SR405FLJ, PE-SR405TN, RG405	PE4876	\$22.93	\$21.32	\$19.72	\$18.34	31
Plug Right Angle									
Cable Connectors		Crimp/Solder	RG174, RG316, RG188, LMR-100, PE-B100, PE-C100, .100 inch	PE4553	\$15.80	\$14.69	\$13.59	\$12.64	32
			RG178, RG196	PE4554	\$16.01	\$14.89	\$13.77	\$12.81	33
			RG58, RG303, RG141, PE-C195, PE-P195, LMR-195, .195 inch	PE4882	\$18.50	\$17.21	\$15.91	\$14.80	34
			Solder/Solder	PE-SR405AL, PE-SR405FL, PE-SR405FLJ, PE-SR405TN, RG405	PE44698	\$7.23	\$6.72	\$6.22	\$5.78
Jack									
Cable Connectors		Crimp/Solder	RG188-DS, RG316-DS	PE4885	\$15.18	\$14.12	\$13.05	\$12.14	36
PCB Mount		Solder	Thru Hole with .200 inch x .067 inch Hole Spacing	PE44303	\$14.83	\$13.79	\$12.75	\$11.86	37
			Thru Hole with .200 inch x .052 inch Hole Spacing	PE4555	\$11.59	\$10.78	\$9.97	\$9.27	38
			.042 inch End Launch	PE4893	\$19.86	\$18.47	\$17.08	\$15.89	39

* Fits MIL-C-17 and equivalent cable versions only



Free Shipping Available
via UPS Ground to
USA & Canada



Technical
Support
(866) 727-8376







Same-Day Shipping,
Even Custom
Cable Assemblies

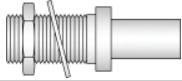

Connectors

See Our Website For Current Pricing & Real-Time Stock Availability!



MCX Connectors

Connection Method	Product Image	Attachment Cable/Contact	Coax Type / Termination Type	Model No.	Price				ROW
					1-24	25-49	50-99	100 +	
Jack, Bulkhead Mount									
Cable Connectors		Crimp/Solder	RG174, RG316, RG188, LMR-100, PE-B100, PE-C100, .100 inch with .177 inch D Hole	PE4887	\$19.69	\$18.31	\$16.93	\$15.75	40
Terminal		Solder	Turret with .177 inch D Hole	PE4561	\$16.31	\$15.17	\$14.03	\$13.05	41
Jack, 2 Hole Flange Mount									
Terminal		Solder	Solder Cup with .328 inch Hole Spacing	PE4891	\$23.74	\$22.08	\$20.42	\$18.99	42
			Pin with .328 inch Hole Spacing	PE4894	\$20.99	\$19.52	\$18.05	\$16.79	43
Jack Right Angle									
PCB Mount		Solder	Thru Hole with .200 inch x .052 inch Hole Spacing	PE45274	\$12.97	\$12.06	\$11.15	\$10.38	44
			Thru Hole with .200 inch x .052 inch Hole Spacing	PE4556	\$14.56	\$13.54	\$12.52	\$11.65	45

Reverse Polarity MCX Connectors

Connection Method	Product Image	Attachment Cable/Contact	Coax Type / Termination Type	Model No.	Price				ROW
					1-24	25-49	50-99	100 +	
Plug Right Angle									
Cable Connectors		Crimp/Solder	RG316, RG188, RG174	PE45050	\$7.04	\$6.55	\$6.05	\$5.63	46
Jack Right Angle, Bulkhead Mount									
PCB Mount		Solder	Thru Hole with .177 inch D Hole	PE44376	\$30.17	\$28.06	\$25.95	\$24.14	47

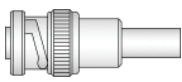
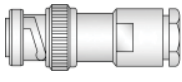
MHV Connectors

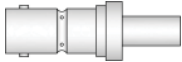



Connection Method	Product Image	Attachment Cable/Contact	Coax Type / Termination Type	Model No.	Price				ROW
					1-24	25-49	50-99	100 +	
Male									
Cable Connectors		Crimp/Solder	RG59*, RG62*, RG71	PE4075	\$15.15	\$14.09	\$13.03	\$12.12	48
			RG58, RG303, RG141, PE-C195, PE-P195, LMR-195, .195 inch	PE4093	\$24.65	\$22.92	\$21.20	\$19.72	49
			RG213, RG8	PE4493	\$29.10	\$27.06	\$25.03	\$23.28	50
			RG55, RG141, RG142, RG223, RG400	PE4657	\$17.90	\$16.65	\$15.39	\$14.32	51
			RG174, RG316, RG188, LMR-100, PE-B100, PE-C100, .100 inch	PE4933	\$38.14	\$35.47	\$32.80	\$30.51	52
			RG58, RG55, RG141, RG142, RG223, RG400, RG303, PE-C195, PE-P195, LMR-195	PE4076	\$14.29	\$13.29	\$12.29	\$11.43	53
Cable Connectors		Clamp/Solder	RG59*, RG62*, RG71	PE4098	\$14.56	\$13.54	\$12.52	\$11.65	54
			RG213, RG214, RG8, RG9, RG11*, RG225, RG393, RG144*, RG216*, RG215	PE4299	\$29.89	\$27.80	\$25.71	\$23.91	55
			RG174, RG316, RG188	PE4494	\$15.72	\$14.62	\$13.52	\$12.58	56
			Male Right Angle						
Cable Connectors		Clamp/Solder	RG58, RG55, RG141, RG142, RG223, RG400, RG303, PE-C195, PE-P195, LMR-195	PE4226	\$32.32	\$30.06	\$27.80	\$25.86	57
			RG59*, RG62*, RG71	PE4227	\$31.60	\$29.39	\$27.18	\$25.28	58
			RG174, RG316, RG188	PE4710	\$30.57	\$28.43	\$26.29	\$24.46	59
Female									
Cable Connectors		Crimp/Solder	PE-P195, PE-C195, RG58, RG141, RG303, .195 inch, LMR-195	PE44102	\$27.18	\$25.28	\$23.37	\$21.74	60

* Fits MIL-C-17 and equivalent cable versions only



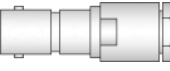

Connectors

See Our Website For Current Pricing & Real-Time Stock Availability!

MHV Connectors

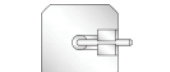
Connection Method	Product Image	Attachment Cable/Contact	Coax Type / Termination Type	Model No.	Price				ROW
					1-24	25-49	50-99	100 +	
Female									
Cable Connectors		Clamp/Solder	RG59*, RG62*, RG71	PE4181	\$22.12	\$20.57	\$19.02	\$17.70	61
			RG58, RG55, RG141, RG142, RG223, RG400, RG303, PE-C195, PE-P195, LMR-195	PE4225	\$23.90	\$22.23	\$20.55	\$19.12	62
			RG174, RG316, RG188	PE44104	\$26.20	\$24.37	\$22.53	\$20.96	63
Female, Bulkhead Mount									
Cable Connectors		Crimp/Solder	RG58, RG303, RG141, PE-C195, PE-P195, LMR-195, .195 inch	PE44108	\$35.78	\$33.28	\$30.77	\$28.62	64
			RG59*, RG62*, RG71	PE44110	\$47.10	\$43.80	\$40.51	\$37.68	65
Terminal		Solder	Solder Cup with .380 inch DD Hole	PE4193	\$21.07	\$19.60	\$18.12	\$16.86	67
			Solder Cup with .380 inch DD Hole	PE4311	\$45.46	\$42.28	\$39.10	\$36.37	68
			Turret with .537 inch D Hole	PE4312	\$35.52	\$33.03	\$30.55	\$28.42	69
			Solder Cup with .480 inch D Hole	PE4495	\$43.71	\$40.65	\$37.59	\$34.97	70
Female, 4 Hole Flange Mount									
Cable Connectors		Clamp/Solder	RG58, RG142, RG223, RG400, RG141, RG303, RG55, LMR-400, PE-C195, PE-P195 with .500 inch Threaded Hole Spacing	PE4313	\$42.27	\$39.31	\$36.35	\$33.82	71
			RG214, RG213, RG393, RG8, RG225, RG11*, RG216*, RG144*, RG215, RG9 with .718 inch Hole Spacing	PE44112	\$48.46	\$45.07	\$41.68	\$38.77	72
Terminal		Solder	Solder Cup with .500 inch Threaded Hole Spacing	PE4228	\$28.15	\$26.18	\$24.21	\$22.52	73
			Solder Cup	PE45035	\$52.10	\$48.45	\$44.81	\$41.68	74

Mini SMP Connectors

Connection Method	Product Image	Attachment Cable/Contact	Coax Type / Termination Type	Model No.	Price				ROW
					1-24	25-49	50-99	100 +	
Male									
PCB Mount		Solder	Surface Mount	PE44489	\$30.83	\$28.67	\$26.51	\$24.66	75
			End Launch	PE44490	\$24.11	\$22.42	\$20.73	\$19.29	76
			Edge Launch	PE44969	\$28.40	\$26.41	\$24.42	\$22.72	77
			Thru Hole	PE44970	\$53.81	\$50.04	\$46.28	\$43.05	78
Male Right Angle									
PCB Mount		Solder	Surface Mount	PE44968	\$65.44	\$60.86	\$56.28	\$52.35	79
Female									
Cable Connectors		Solder	PE-047SR, PE-SR047AL, PE-SR047FL	PE44491	\$35.52	\$33.03	\$30.55	\$28.42	80
			PE-SR405AL, PE-SR405FL, PE-SR405FLJ, PE-SR405TN, RG405	PE44492	\$35.04	\$32.59	\$30.13	\$28.03	81
			PE-SR405AL, PE-SR405FL, PE-SR405FLJ, PE-SR405TN, RG405	PE44974	\$34.38	\$31.97	\$29.57	\$27.50	82
Female Right Angle									
Cable Connectors		Solder	PE-047SR, PE-SR047AL, PE-SR047FL	PE44493	\$45.27	\$42.10	\$38.93	\$36.22	83
			PE-SR405AL, PE-SR405FL, PE-SR405FLJ, PE-SR405TN, RG405	PE44494	\$40.73	\$37.88	\$35.03	\$32.58	84

Mini UHF Connectors

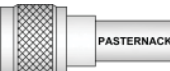
Connection Method	Product Image	Attachment Cable/Contact	Coax Type / Termination Type	Model No.	Price				ROW
					1-24	25-49	50-99	100 +	
Male									
Cable Connectors		Crimp/Solder	RG58, RG303, RG141, PE-C195, PE-P195, LMR-195, .195 inch	PE4342	\$6.40	\$5.95	\$5.50	\$5.12	85

* Fits MIL-C-17 and equivalent cable versions only



Free Shipping Available
via UPS Ground to
USA & Canada



Technical Support
(866) 727-8376





Same-Day Shipping,
Even Custom
Cable Assemblies





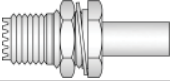

Connectors

See Our Website For Current Pricing & Real-Time Stock Availability!

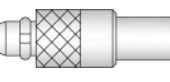

Mini UHF Connectors

Connection Method	Product Image	Attachment Cable/Contact	Coax Type / Termination Type	Model No.	Price				ROW
					1-24	25-49	50-99	100 +	
Female, Bulkhead Mount									
Cable Connectors		Crimp/Solder	.195 inch, RG58, RG141, RG303, LMR-195, LMR-195-FR, PE-C195, PE-P195 with .410 inch D Hole	PE44087	\$14.30	\$13.30	\$12.30	\$11.44	86
PCB Mount		Solder	Thru Hole with .380 inch Diameter	PE44092	\$10.17	\$9.46	\$8.75	\$8.14	87

MMCX Connectors

Connection Method	Product Image	Attachment Cable/Contact	Coax Type / Termination Type	Model No.	Price				ROW
					1-24	25-49	50-99	100 +	
Plug									
Cable Connectors		Crimp/Solder	RG174, RG316, RG188, LMR-100, PE-B100, PE-C100, .100 inch	PE4896	\$16.24	\$15.10	\$13.97	\$12.99	88
Cable Connectors		Solder	PE-047SR, PE-SR047AL, PE-SR047FL	PE44456	\$21.58	\$20.07	\$18.56	\$17.26	89
PCB Mount			End Launch	PE44663	\$20.09	\$18.68	\$17.28	\$16.07	90
Plug Right Angle									
Cable Connectors		Crimp/Solder	RG174, RG316, RG188, LMR-100, PE-B100, PE-C100, .100 inch	PE4898	\$12.17	\$11.32	\$10.47	\$9.74	91
Cable Connectors		Solder/Solder	RG178, RG196	PE4899	\$17.33	\$16.12	\$14.90	\$13.86	92
Cable Connectors			PE-SR405AL, PE-SR405FL, PE-SR405FLJ, PE-SR405TN, RG405	PE44699	\$7.91	\$7.36	\$6.80	\$6.33	93
Jack									
PCB Mount		Solder	Thru Hole with .100 inch x .031 inch Hole Spacing	PE4904	\$12.64	\$11.76	\$10.87	\$10.11	94
Jack Right Angle									
PCB Mount		Solder	Thru Hole with .100 inch x .031 inch Hole Spacing	PE4903	\$21.10	\$19.62	\$18.15	\$16.88	95

MMBX Connectors



Connection Method	Product Image	Attachment Cable/Contact	Coax Type / Termination Type	Model No.	Price				ROW
					1-24	25-49	50-99	100 +	
Plug									
Cable Connectors		Crimp/Solder	RG178, RG196	PE45250	\$12.22	\$11.36	\$10.51	\$9.78	96
Cable Connectors			RG316, RG174	PE45251	\$12.22	\$11.36	\$10.51	\$9.78	97
Cable Connectors			RG316-DS, RG188-DS	PE45252	\$12.22	\$11.36	\$10.51	\$9.78	98
PCB Mount		Solder/Solder	Surface Mount	PE45259TR1	\$17.09	\$15.89	\$14.70	\$13.67	99
PCB Mount			Surface Mount	PE45259 TR750	Call	Call	Call	Call	1
Cable Connectors		Solder/Non-Solder Contact	RG405, PE-SR405FL, PE-SR405FLJ	PE45253	\$13.72	\$12.76	\$11.80	\$10.98	2

* Fits MIL-C-17 and equivalent cable versions only

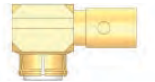

Connectors

See Our Website For Current Pricing & Real-Time Stock Availability!

MMBX Connectors

Connection Method	Product Image	Attachment Cable/Contact	Coax Type / Termination Type	Model No.	Price				ROW
					1-24	25-49	50-99	100 +	
Plug Right Angle									
Cable Connectors		Crimp/Solder	RG178, RG196	PE45254	\$15.86	\$14.75	\$13.64	\$12.69	3
			RG316, RG174	PE45255	\$15.86	\$14.75	\$13.64	\$12.69	4
			RG316-DS, RG188-DS	PE45256	\$15.86	\$14.75	\$13.64	\$12.69	5
		Solder/Solder	RG405, PE-SR405FL, PE-SR405FLJ	PE45257	\$15.86	\$14.75	\$13.64	\$12.69	6
Jack									
PCB Mount		Solder	Edge Launch	PE45261	\$15.60	\$14.51	\$13.42	\$12.48	7
			Surface Mount	PE45262TR1	\$10.55	\$9.81	\$9.07	\$8.44	8
			Surface Mount	PE45262TR750	Call	Call	Call	Call	9
			Through Hole	PE45265TR1	\$13.26	\$12.33	\$11.40	\$10.61	10
			Through Hole	PE45265TR500	Call	Call	Call	Call	11
Jack, Thread-In									
Terminal		Solder	Pin	PE45267	\$11.86	\$11.03	\$10.20	\$9.49	12

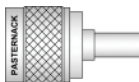
N Connectors

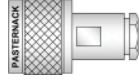
Connection Method	Product Image	Attachment Cable/Contact	Coax Type / Termination Type	Model No.	Price				ROW
					1-24	25-49	50-99	100 +	
Male									
Cable Connectors		Crimp/Crimp	RG55, RG141, RG142, RG223, RG400	PE4042	\$17.41	\$16.19	\$14.97	\$13.93	13
			PE-C195, PE-P195, RG58, RG141, RG303, LMR-195, .195 inch	PE44520	\$9.38	\$8.72	\$8.07	\$7.50	14
		Crimp/Solder	RG214, RG9, RG225, RG393	PE4048	\$17.93	\$16.67	\$15.42	\$14.34	15
			RG58, RG141, RG303, LMR-195, PE-C195, PE-P195, .195 inch	PE4329	\$13.11	\$12.19	\$11.27	\$10.49	16
			RG8X, PE-C240, .240 inch, B7808A, LMR-240	PE4344	\$12.56	\$11.68	\$10.80	\$10.05	17
			RG174, RG316, RG188, LMR-100, PE-B100, PE-C100, .100 inch	PE4429	\$16.73	\$15.56	\$14.39	\$13.38	18
			RG213, RG215, RG8	PE4430	\$16.24	\$15.10	\$13.97	\$12.99	19
			RG59*, RG62*, RG71	PE4432	\$14.70	\$13.67	\$12.64	\$11.76	20
			PE-C600, LMR-600, LMR-600-DB, .600 inch	PE44454	\$27.50	\$25.58	\$23.65	\$22.00	21
			PE-C240, RG8X, .240 inch, LMR-240, LMR-240-DB, LMR-240-UF, B7808A	PE44521	\$14.62	\$13.60	\$12.57	\$11.70	22
			PE-C400, PE-B400, PE-B405, LMR-400, LMR-400-DB, LMR-400-UF, .400 inch	PE44522	\$16.53	\$15.37	\$14.22	\$13.22	23
			PE-C600, LMR-600, LMR-600-DB, .600 inch	PE44523	\$55.31	\$51.44	\$47.57	\$44.25	24
			RG223, RG142, RG400, RG55	PE44788	\$15.33	\$14.26	\$13.18	\$12.26	25
			RG188-DS, RG316-DS	PE45167	\$15.72	\$14.62	\$13.52	\$12.58	26
			PE-B400, PE-B405, PE-C400, LMR-400, .400 inch	PE4550	\$15.09	\$14.03	\$12.98	\$12.07	27
			LMR-195, PE-C195	TC-195-NMH-X	\$13.69	\$13.69	\$13.69	\$13.69	28
			LMR-200, PE-C200	TC-200-NMH-X	\$16.65	\$16.65	\$16.65	\$16.65	29
			LMR-240, PE-C240	TC-240-NMH-X	\$12.51	\$12.51	\$12.51	\$12.51	30
			LMR-400, PE-C400, PE-B405	TC-400-NMH-X	\$13.00	\$13.00	\$13.00	\$13.00	31
			LMR-600, PE-C600	TC-600-NMH-X	\$19.08	\$19.08	\$19.08	\$19.08	32
	Clamp	7/8 inch Annular, 7/8 inch Helical, 7/8 inch Superflexible, 7/8 inch Flexible	PE44976	\$52.46	\$48.79	\$45.12	\$41.97	33	
	Clamp/Solder	PE-SR402AL, PE-SR402FL, RG402	PE4006	\$18.63	\$17.33	\$16.02	\$14.90	34	
		RG213, RG214, RG8, RG9, RG11*, RG225, RG393, RG144*, RG216*, RG215	PE4062	\$15.37	\$14.29	\$13.22	\$12.30	35	
		RG58, RG55, RG141, RG142, RG223, RG400, RG303, PE-C195, PE-P195, LMR-195	PE4081	\$12.17	\$11.32	\$10.47	\$9.74	36	
		PE-SR405AL, PE-SR405FL, RG405	PE4129	\$18.63	\$17.33	\$16.02	\$14.90	37	
		PE-C400, PE-B400, PE-B405, LMR-400, LMR-400-DB, LMR-400-UF, .400 inch	PE4133	\$20.64	\$19.20	\$17.75	\$16.51	38	
RG14, RG217	PE4221	\$29.75	\$27.67	\$25.59	\$23.80	39			

* Fits MIL-C-17 and equivalent cable versions only



Free Shipping Available
via UPS Ground to
USA & Canada









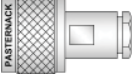
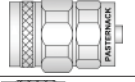

Technical Support
(866) 727-8376



Same-Day Shipping,
Even Custom
Cable Assemblies

N Connectors

Connection Method	Product Image	Attachment Cable/Contact	Coax Type / Termination Type	Model No.	Price				ROW
					1-24	25-49	50-99	100 +	
Cable Connectors	Male								
		Clamp/Solder	RG174, RG316, RG188	PE4224	\$15.72	\$14.62	\$13.52	\$12.58	40
			RG59*, RG62*, RG71	PE4331	\$17.26	\$16.05	\$14.84	\$13.81	41
			PE-C300	PE44045	\$19.34	\$17.99	\$16.63	\$15.47	42
			PE-C500, LMR-500	PE44046	\$32.39	\$30.12	\$27.86	\$25.91	43
			RG17, RG218, RG219	PE4433	\$91.68	\$85.26	\$78.84	\$73.34	44
			PE-SR401AL, PE-SR401FL, RG401	PE4434	\$18.63	\$17.33	\$16.02	\$14.90	45
	PE-C600, .600 inch, LMR-600	PE44349	\$63.65	\$59.19	\$54.74	\$50.92	46		
		Threaded	VNA Test Cable	PE44485	Call	Call	Call	Call	47
		Clamp/Solder	PE-P160LL	PE45446	\$77.42	\$72.00	\$66.58	\$61.94	48
			LMR-240, PE-C240	TC-240-NMC	\$15.63	\$15.63	\$15.63	\$15.63	49
		Clamp/Solder (Captive Contact)	RG213, RG214, RG8, RG9, RG11*, RG225, RG393, RG144*, RG216*, RG215	PE4132	\$16.22	\$15.08	\$13.95	\$12.98	50
			PE-SR402AL, PE-SR402FL, PE-SR402FLJ, PE-SR402TN, RG402	PE4140	\$23.66	\$22.00	\$20.35	\$18.93	51
		Solder/Solder	PE-SR401AL, PE-SR401FL, RG401	PE4376	\$41.04	\$38.17	\$35.29	\$32.83	52
			SPP-250-LLPL	PE45427	\$24.31	\$22.61	\$20.91	\$19.45	53
		Clamp/Non-Solder Contact	LMR-400, PE-C400, PE-B400, PE-B405	EZ-400-NMC-2-D	\$23.13	\$23.13	\$23.13	\$23.13	54
			LMR-600, PE-C600	EZ-600-NMC-2-D	\$36.99	\$36.99	\$36.99	\$36.99	55
			LMR-SW540	EZ-SW540-NMC	\$22.20	\$22.20	\$22.20	\$22.20	56
			1/4 inch Superflexible, PE-1/4SFHC	PE44726	\$52.69	\$49.00	\$45.31	\$42.15	57
			1/2 inch Helical, 1/2 inch Superflexible, PE-1/2 Helical, PE-1/2SFHC	PE44729	\$36.80	\$34.22	\$31.65	\$29.44	58
	PE-1/2FAC, 1/2 inch Flexible, 1/2 inch Annular	PE44735	\$35.71	\$33.21	\$30.71	\$28.57	59		
		Crimp/Non-Solder Contact	LMR-200, PE-C200	EZ-200-NMH-X	\$16.65	\$16.65	\$16.65	\$16.65	60
			LMR-240, PE-C240, RG8X	EZ-240-NMH-X	\$12.34	\$12.34	\$12.34	\$12.34	61
			LMR-400, PE-C400	EZ-400-NMH-PL-X	\$14.86	\$14.86	\$14.86	\$14.86	62
LMR-400, PE-C400, PE-B400, PE-B405			EZ-400-NMH-X	\$13.87	\$13.87	\$13.87	\$13.87	63	
LMR-600, PE-C600			EZ-600-NMH-X	\$20.23	\$20.23	\$20.23	\$20.23	64	
Terminal	Male, Bulkhead Mount								
		Solder	Solder Cup with .640 inch DD Hole	PE4489	\$33.63	\$31.28	\$28.92	\$26.90	65
Solder Cup with .350 inch D Hole			PE4490	\$36.43	\$33.88	\$31.33	\$29.14	66	
Terminal	Male, 4 Hole Flange Mount								
		Solder	Solder Cup with .718 inch Hole Spacing	PE4131	\$14.92	\$13.88	\$12.83	\$11.94	67
			Pin with .718 inch Hole Spacing	PE44653	\$70.45	\$65.52	\$60.59	\$56.36	68
Pin with .718 inch Hole Spacing			PE4491	\$29.86	\$27.77	\$25.68	\$23.89	69	
Cable Connectors	Male Right Angle								
		Crimp/Solder	PE-C195, PE-P195, RG58, RG141, RG303, LMR-195, .195 inch	PE44524	\$31.12	\$28.94	\$26.76	\$24.90	70
			PE-C240, RG8X, .240 inch, LMR-240, LMR-240-DB, LMR-240-UF, B7808A	PE44525	\$48.59	\$45.19	\$41.79	\$38.87	71
			PE-C400, PE-B400, PE-B405, LMR-400, LMR-400-DB, LMR-400-UF, .400 inch	PE44526	\$36.50	\$33.95	\$31.39	\$29.20	72
			PE-C600, LMR-600, LMR-600-DB, .600 inch	PE44527	\$60.52	\$56.28	\$52.05	\$48.42	73
			RG174, RG316, RG188, .100 inch, PE-B100, PE-C100, LMR-100	PE44675	\$27.76	\$25.82	\$23.87	\$22.21	74
			RG213, RG8	PE4482	\$33.54	\$31.19	\$28.84	\$26.83	75
			RG214, RG9, RG225, RG393	PE4483	\$43.89	\$40.82	\$37.75	\$35.11	76

* Fits MIL-C-17 and equivalent cable versions only

Connectors

See Our Website For Current Pricing & Real-Time Stock Availability!

N Connectors

Connection Method	Product Image	Attachment Cable/Contact	Coax Type / Termination Type	Model No.	Price				ROW
					1-24	25-49	50-99	100 +	
Male Right Angle									
Cable Connectors		Crimp/Solder	RG55, RG141, RG142, RG223, RG400	PE4484	\$27.98	\$26.02	\$24.06	\$22.38	77
			PE-C200, LMR-200	PE44844	\$48.80	\$45.38	\$41.97	\$39.04	78
		Clamp/Solder	RG58, RG55, RG141, RG142, RG223, RG400, RG303, PE-C195, PE-P195, LMR-195	PE4135	\$20.53	\$19.09	\$17.66	\$16.42	79
			RG213, RG8, RG215, RG225, RG214, RG393	PE4136	\$23.66	\$22.00	\$20.35	\$18.93	80
			PE-P142LL	PE44816	\$140.66	\$130.81	\$120.97	\$112.53	81
			1/2 inch Annular, 1/2 inch Flexible, PE-1/2FAC	PE45358	\$76.55	\$71.19	\$65.83	\$61.24	82
			PE-P160LL	PE45448	\$133.97	\$124.59	\$115.21	\$107.18	83
		Solder/Solder	PE-SR401AL, PE-SR401FL, RG401	PE4935	\$27.60	\$25.67	\$23.74	\$22.08	84
			PE-SR405AL, PE-SR405FL, PE-SR405FLJ, RG405	PE44702	\$19.41	\$18.05	\$16.69	\$15.53	85
			SPP-250-LLPL	PE45428	\$28.48	\$26.49	\$24.49	\$22.78	86
			PE-SR402AL, PE-SR402FL, RG402	PE4936	\$30.14	\$28.03	\$25.92	\$24.11	87
			PE-SR405AL, PE-SR405FL, PE-SR405FLJ, RG405	PE4937	\$25.67	\$23.87	\$22.08	\$20.54	88
		Crimp/Non-Solder Contact	LMR-400, PE-C400, PE-B400	TC-400-NMH-RA-D	\$20.81	\$20.81	\$20.81	\$20.81	89
			PE-B405	EZ-400-NMH-RA-X	\$23.13	\$23.13	\$23.13	\$23.13	90
LMR-600, PE-C600			EZ-600-NMH-RA-X	\$28.91	\$28.91	\$28.91	\$28.91	91	
Female									
Cable Connectors		Crimp/Solder	RG55, RG141, RG142, RG223, RG400	PE4134	\$16.00	\$14.88	\$13.76	\$12.80	92
			RG214, RG9, RG225, RG393	PE4191	\$15.25	\$14.18	\$13.12	\$12.20	93
			RG58	PE4436	\$14.46	\$13.45	\$12.44	\$11.57	94
			PE-C195, PE-P195, RG58, RG141, RG303, LMR-195, .195 inch	PE44532	\$14.90	\$13.86	\$12.81	\$11.92	95
			PE-C240, RG8X, .240 inch, LMR-240, LMR-240-DB, LMR-240-UF, B7808A	PE44533	\$15.95	\$14.83	\$13.72	\$12.76	96
			PE-C400, PE-B400, PE-B405, LMR-400, LMR-400-DB, LMR-400-UF, .400 inch	PE44534	\$23.44	\$21.80	\$20.16	\$18.75	97
			PE-C600, LMR-600, LMR-600-DB, .600 inch	PE44535	\$44.90	\$41.76	\$38.61	\$35.92	98
			LMR-400, PE-C400	TC-400-NF-X	\$17.85	\$17.85	\$17.85	\$17.85	99
		Clamp/Solder	RG213, RG214, RG8, RG9, RG11*, RG225, RG393, RG144*, RG216*, RG215	PE4061	\$16.95	\$15.76	\$14.58	\$13.56	1
			RG58, RG55, RG141, RG142, RG223, RG400, RG303, PE-C195, PE-P195, LMR-195	PE4072	\$16.15	\$15.02	\$13.89	\$12.92	2
			RG59*, RG62*, RG71	PE4330	\$16.34	\$15.20	\$14.05	\$13.07	3
			PE-B400, PE-B405, PE-C400, LMR-400, .400 inch	PE4372	\$27.89	\$25.94	\$23.99	\$22.31	4
		Solder/Solder	PE-SR402AL, PE-SR402FL, PE-SR402FLJ, PE-SR402TN, RG402	PE44705	\$21.36	\$19.86	\$18.37	\$17.09	8
			SPP-250-LLPL	PE45426	\$24.31	\$22.61	\$20.91	\$19.45	9
	Crimp/Non-Solder Contact	PE-SR402AL, PE-SR402FL, RG402	PE4652	\$40.58	\$37.74	\$34.90	\$32.46	10	
		PE-SR402AL, PE-SR402FL, RG402	PE44396	\$24.34	\$22.64	\$20.93	\$19.47	11	
PCB Mount		Solder	Thru Hole with .400 inch x .062 inch Hole Spacing	PE44396	\$24.34	\$22.64	\$20.93	\$19.47	11
Cable Connectors		Clamp/Non-Solder Contact	1/2 inch Helical, 1/2 inch Superflexible, PE-1/2 Helical, PE-1/2SFHC	PE44731	\$40.51	\$37.67	\$34.84	\$32.41	12
			PE-1/2FAC, 1/2 inch Flexible, 1/2 inch Annular	PE44737	\$40.51	\$37.67	\$34.84	\$32.41	13
			7/8 inch Helical	PE45203	\$48.62	\$45.22	\$41.81	\$38.90	14
Cable Connectors		Crimp/Non-Solder Contact	LMR-600, PE-C600	EZ-600-NF-X	\$24.01	\$24.01	\$24.01	\$24.01	15
			Female, Bulkhead Mount						
Cable Connectors		Crimp/Solder	RG55, RG141, RG142, RG223, RG400 with .640 inch DD Hole	PE4371	\$19.37	\$18.01	\$16.66	\$15.50	16

Connectors

See Our Website For Current Pricing & Real-Time Stock Availability!

* Fits MIL-C-17 and equivalent cable versions only



Free Shipping Available
via UPS Ground
to USA & Canada









Technical Support
(866) 727-8376

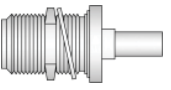
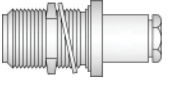

Same-Day Shipping,
Even Custom
Cable Assemblies

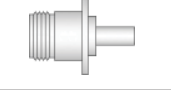
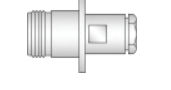
N Connectors

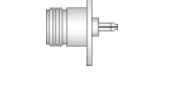



Connection Method	Product Image	Attachment Cable/Contact	Coax Type / Termination Type	Model No.	Price				ROW	
					1-24	25-49	50-99	100 +		
Cable Connectors	Female, Bulkhead Mount									
		Crimp/Solder	RG58 with .640 inch DD Hole	PE4440	\$15.96	\$14.84	\$13.73	\$12.77	17	
			RG174, RG316, RG188, LMR-100, PE-B100, PE-C100, .100 inch with .640 inch DD Hole	PE4442	\$27.31	\$25.40	\$23.49	\$21.85	18	
			.240 inch, RG8X, LMR-240, B7808A, LMR-240-DB, LMR-240-UF, PE-C240 with .640 inch DD Hole	PE44529	\$16.45	\$15.30	\$14.15	\$13.16	19	
			.400 inch, LMR-400, LMR-400-DB, LMR-400-UF, PE-B405, PE-C400, PE-B400 with .640 inch DD Hole	PE44530	\$22.51	\$20.93	\$19.36	\$18.01	20	
			RG188-DS, RG316-DS	PE44877	\$26.42	\$24.57	\$22.72	\$21.14	21	
			LMR-200, PE-C200	PE45047	\$22.60	\$22.60	\$22.60	\$22.60	22	
			RG214, RG9, RG225, RG393 with .640 inch DD Hole	PE4941	\$16.86	\$15.68	\$14.50	\$13.49	23	
			LMR-240, PE-C240	TC-240-NF-BH-X	\$27.28	\$27.28	\$27.28	\$27.28	24	
		Clamp/Solder	RG58, RG142, RG223, RG400, RG141, RG303, RG55, LMR-400, PE-C195, PE-P195 with .640 inch DD Hole	PE4114	\$19.54	\$18.17	\$16.80	\$15.63	25	
			RG214, RG213, RG393, RG8, RG225, RG11*, RG216*, RG144*, RG215, RG9 with .640 inch DD Hole	PE4223	\$24.11	\$22.42	\$20.73	\$19.29	26	
			RG174, RG316, RG188 with .640 inch DD Hole	PE4441	\$20.20	\$18.79	\$17.37	\$16.16	27	
			PE-P300LL	PE44807	\$99.81	\$92.82	\$85.84	\$79.85	28	
			PE-P142LL	PE44813	\$84.46	\$78.55	\$72.64	\$67.57	29	
			PE-P160LL	PE45447	\$102.71	\$95.52	\$88.33	\$82.17	30	
			PE-SR401AL, PE-SR401FL, RG401 with .640 inch DD Hole	PE4942	\$23.17	\$21.55	\$19.93	\$18.54	31	
			PE-SR405AL, PE-SR405FL, PE-SR405FLJ, PE-SR405TN, RG405	PE44706	\$21.36	\$19.86	\$18.37	\$17.09	32	
		Solder/Solder	PE-SR402AL, PE-SR402FL, PE-SR402FLJ, PE-SR402TN, RG402	PE44707	\$20.96	\$19.49	\$18.03	\$16.77	33	
			PE-SR402AL, PE-SR402FL, PE-SR402FLJ, PE-SR402TN, RG402 with .640 inch DD Hole	PE4654	\$34.47	\$32.06	\$29.64	\$27.58	34	
			PE-SR405AL, PE-SR405FL, RG405 with .640 inch DD Hole	PE4655	\$34.40	\$31.99	\$29.58	\$27.52	35	
			Thru Hole with .640 inch DD Hole	PE44397	\$33.80	\$31.43	\$29.07	\$27.04	36	
			End Launch with .630 inch Diameter	PE44615	\$30.10	\$27.99	\$25.89	\$24.08	37	
			Solder Cup with .640 inch DD Hole	PE4137	\$17.44	\$16.22	\$15.00	\$13.95	38	
	Terminal		Pin with .640 inch DD Hole	PE4139	\$11.12	\$10.34	\$9.56	\$8.90	39	
			Solder Cup with .380 inch Diameter	PE4488	\$13.22	\$12.29	\$11.37	\$10.58	40	
	Cable Connectors		Crimp/Non-Solder Contact	LMR-400, PE-C400, PE-B400, PE-B405	EZ-400-NF-BH	\$23.13	\$23.13	\$23.13	\$23.13	41
	Terminal	Female, 2 Hole Flange Mount								
			Solder	Pin with 1.0 inch Hole Spacing	PE44079	\$43.78	\$40.72	\$37.65	\$35.02	42
	Cable Connectors	Female, 4 Hole Flange Mount								
			Crimp/Solder	RG55, RG141, RG142, RG223, RG400 with .718 inch Hole Spacing	PE44068	\$22.17	\$20.62	\$19.07	\$17.74	43
				.195 inch, RG58, RG141, RG303, LMR-195, LMR-195-FR, PE-C195, PE-P195 with .718 inch Hole Spacing	PE44069	\$22.80	\$21.20	\$19.61	\$18.24	44
				RG316, RG174, LMR-100	PE45133	\$20.50	\$19.07	\$17.63	\$16.40	45
			Clamp/Solder	RG58, RG142, RG223, RG400, RG141, RG303, RG55, LMR-400, PE-C195, PE-P195 with .718 inch Hole Spacing	PE4141	\$16.77	\$15.60	\$14.42	\$13.42	46
				PE-SR401AL, PE-SR401FL, RG401 with .718 inch Hole Spacing	PE44071	\$23.17	\$21.55	\$19.93	\$18.54	47
PE-SR402AL, PE-SR402FL, PE-SR402FLJ, PE-SR402TN, RG402 with .718 inch Hole Spacing				PE44072	\$23.17	\$21.55	\$19.93	\$18.54	48	
PE-SR405AL, PE-SR405FL, RG405 with .718 inch Hole Spacing				PE44073	\$22.81	\$21.21	\$19.62	\$18.25	49	
		Clamp/Solder (Captive Contact)	RG214, RG213, RG393, RG8, RG225, RG11*, RG216*, RG144*, RG215, RG9 with .718 inch Hole Spacing	PE4060	\$24.56	\$22.84	\$21.12	\$19.65	50	
			Solder Cup with .718 inch Hole Spacing	PE4013	\$11.92	\$11.09	\$10.25	\$9.54	51	
	Pin with .718 inch Hole Spacing		PE4328	\$18.58	\$17.28	\$15.98	\$14.86	52		
Terminal		Solder	Pin with .340 inch Hole Spacing	PE4355	\$19.07	\$17.74	\$16.40	\$15.26	53	
			Pin with .500 inch Hole Spacing	PE4444	\$20.92	\$19.46	\$17.99	\$16.74	54	
			Solder Cup with .718 inch Hole Spacing	PE4487	\$52.89	\$49.19	\$45.49	\$42.31	55	
			Tab with .718 inch Hole Spacing	PE4492	\$27.29	\$25.38	\$23.47	\$21.83	56	
			Solder Cup	PE45085	\$13.55	\$12.60	\$11.65	\$10.84	57	

* Fits MIL-C-17 and equivalent cable versions only

Connectors

See Our Website For Current Pricing & Real-Time Stock Availability!

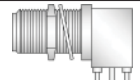
N Connectors

Connection Method	Product Image	Attachment Cable/Contact	Coax Type / Termination Type	Model No.	Price				ROW
					1-24	25-49	50-99	100 +	
Female, 4 Hole Flange Mount									
Terminal		Field Replaceable	Slotted Contact	PE44721	\$29.25	\$27.20	\$25.15	\$23.40	58
			Slotted Contact	PE44722	\$29.54	\$27.47	\$25.40	\$23.63	59
Female, Press-In									
Terminal		Solder	Solder Cup with .500 inch Diameter	PE44076	\$15.50	\$14.42	\$13.33	\$12.40	60
Female Right Angle, Bulkhead Mount									
PCB Mount		Solder	Thru Hole with .596 inch D Hole	PE44398	\$25.36	\$23.58	\$21.81	\$20.29	61
Female Right Angle, 4 Hole Flange Mount									
Terminal		Solder	Solder Cup with .718 inch Hole Spacing	PE4486	\$44.81	\$41.67	\$38.54	\$35.85	62

Reverse Polarity N Connectors

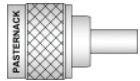
Connection Method	Product Image	Attachment Cable/Contact	Coax Type / Termination Type	Model No.	Price				ROW
					1-24	25-49	50-99	100 +	
Male									
Cable Connectors		Crimp/Solder	PE-C400, PE-B400, PE-B405, LMR-400, LMR-400-DB, LMR-400-UF, .400 inch	PE44470	\$30.99	\$28.82	\$26.65	\$24.79	63
			RG58	PE44473	\$24.87	\$23.13	\$21.39	\$19.90	64
			RG214, RG393	PE44474	\$26.20	\$24.37	\$22.53	\$20.96	65

N, 7mm, SC Torque Wrenches



Type	Bit Hex Size (in.)	Preset Torque (in.-lbs.)	Model No	1-24	25-49	50-99	100+	ROW
N, 7mm, SC	20 mm	14 in-lbs	PE5011-7	\$288.75	\$268.54	\$248.33	\$231.00	
		8.1 in-lbs	PE5019-5	\$215.82	\$200.71	\$185.61	\$172.66	
	3/4 inch	14 in-lbs	PE5019-4	\$213.81	\$198.84	\$183.88	\$171.05	
		14 in-lbs	PE5019-8	\$213.81	\$198.84	\$183.88	\$171.05	

NMO Mount Connectors, [See Web](#) (2 parts available)

QMA Connectors

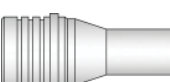
Connection Method	Product Image	Attachment Cable/Contact	Coax Type / Termination Type	Model No.	Price				ROW
					1-24	25-49	50-99	100 +	
Male									
Cable Connectors		Crimp/Solder	RG174, RG316, RG188, .100 inch, PE-B100, PE-C100, LMR-100	PE44501	\$22.71	\$21.12	\$19.53	\$18.17	66
			PE-C195, PE-P195, RG58, RG141, RG303, LMR-195, .195 inch	PE44503	\$18.79	\$17.47	\$16.16	\$15.03	67
			RG55, RG142, RG223, RG400	PE44514	\$19.77	\$18.39	\$17.00	\$15.82	68
			LMR-200, PE-C200	PE45224	\$10.84	\$10.08	\$9.32	\$8.67	69

* Fits MIL-C-17 and equivalent cable versions only



Free Shipping Available via UPS Ground to USA & Canada









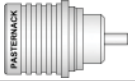

Technical Support (866) 727-8376



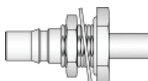

Same-Day Shipping, Even Custom Cable Assemblies

QMA Connectors

Connection Method	Product Image	Attachment Cable/Contact	Coax Type / Termination Type	Model No.	Price				ROW
					1-24	25-49	50-99	100 +	
Male									
Cable Connectors		Solder/Solder	PE-SR405AL, PE-SR405FL, RG405	PE44495	\$20.03	\$18.63	\$17.23	\$16.02	70
			SPP-250-LLPL	PE45430	\$20.84	\$19.38	\$17.92	\$16.67	71
		Solder/Non-Solder Contact	PE-SR402AL, PE-SR402FL, PE-SR402FLJ, PE-SR402TN, RG402	PE44496	\$43.56	\$40.51	\$37.46	\$34.85	72
Male Right Angle									
Cable Connectors		Crimp/Solder	RG55, RG142, RG223, RG400	PE44515	\$26.39	\$24.54	\$22.70	\$21.11	73
			RG174, RG316, RG188	PE45284	\$20.41	\$18.98	\$17.55	\$16.33	74
		Solder/Solder	SPP-250-LLPL	PE45431	\$22.93	\$21.32	\$19.72	\$18.34	75
		Crimp/Non-Solder Contact	LMR-240, PE-C240, LMR-240-UF	EZ-240-QM-RA-X	\$19.50	\$19.50	\$19.50	\$19.50	76
Female									
Cable Connectors		Solder/Solder	SPP-250-LLPL	PE45429	\$17.38	\$16.16	\$14.95	\$13.90	77
PCB Mount		Solder	Thru Hole	PE44512	\$12.79	\$11.89	\$11.00	\$10.23	78
Female, Bulkhead Mount									
Cable Connectors		Crimp/Solder	RG174, RG316, RG188, .100 inch, PE-B100, PE-C100, LMR-100 with .268 inch D Hole	PE44507	\$18.58	\$17.28	\$15.98	\$14.86	79
			RG58, RG141 with .268 inch D Hole	PE44509	\$20.03	\$18.63	\$17.23	\$16.02	80
		Solder/Solder	PE-SR402AL, PE-SR402FL, PE-SR402FLJ, PE-SR402TN, RG402 with .268 inch D Hole	PE44500	\$21.32	\$19.83	\$18.34	\$17.06	81
			PE-SR405AL, PE-SR405FL, RG405 with .268 inch D Hole	PE45218	\$28.66	\$26.65	\$24.65	\$22.93	82

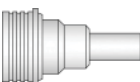

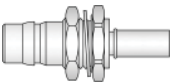

QN Connectors

Connection Method	Product Image	Attachment Cable/Contact	Coax Type / Termination Type	Model No.	Price				ROW
					1-24	25-49	50-99	100 +	
Male									
Cable Connectors		Crimp/Solder	RG213, RG215	PE44597	\$62.84	\$58.44	\$54.04	\$50.27	83
			LMR-240, PE-C240	PE45222	\$30.19	\$28.08	\$25.96	\$24.15	84
Male Right Angle									
Cable Connectors		Crimp/Solder	RG55, RG141, RG142, RG223, RG400	PE44600	\$39.03	\$36.30	\$33.57	\$31.22	85
			PE-C195, PE-P195, RG58, RG141, RG303, LMR-195, .195 inch	PE44601	\$37.13	\$34.53	\$31.93	\$29.70	86
			LMR-400, PE-C400, LMR-400-DB	PE45223	\$47.55	\$44.22	\$40.89	\$38.04	87
Female, Bulkhead Mount									
Cable Connectors		Crimp/Solder	.195 inch, RG58, RG141, RG303, LMR-195, LMR-195-FR, PE-C195, PE-P195 with .500 inch Diameter	PE44606	\$40.62	\$37.78	\$34.93	\$32.50	88
			RG214, RG225 with .500 inch Diameter	PE44608	\$93.92	\$87.35	\$80.77	\$75.14	89

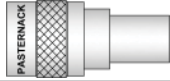
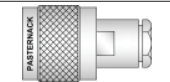

RCA Connectors, [See Web](#) (9 parts available)

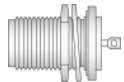
* Fits MIL-C-17 and equivalent cable versions only

SC Connectors

Connection Method	Product Image	Attachment Cable/Contact	Coax Type / Termination Type	Model No.	Price				ROW
					1-24	25-49	50-99	100 +	
Male									
Cable Connectors		Crimp/Solder	RG55, RG141, RG142, RG223, RG400	PE4231	\$113.23	\$105.30	\$97.38	\$90.58	90
			RG214, RG9, RG225, RG393	PE4232	\$61.37	\$57.07	\$52.78	\$49.10	91
		Clamp/Solder	RG213, RG214, RG8, RG9, RG225, RG393, RG215	PE4520	\$160.20	\$148.99	\$137.77	\$128.16	92
Male Right Angle									
Cable Connectors		Clamp/Solder	RG58, RG55, RG141, RG142, RG223, RG400	PE4978	\$129.39	\$120.33	\$111.28	\$103.51	93
			RG213, RG214, RG8, RG9, RG225, RG393, RG215	PE4979	\$151.60	\$140.99	\$130.38	\$121.28	94
Female, Bulkhead Mount									
Terminal		Solder	Eyelet with .655 inch D Hole	PE4980	\$36.85	\$34.27	\$31.69	\$29.48	95
Female, 4 Hole Flange Mount									
Terminal		Solder	Solder Cup with .718 inch Hole Spacing	PE4322	\$37.20	\$34.60	\$31.99	\$29.76	96

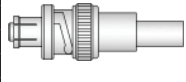
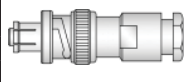
SHV Connectors

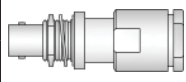
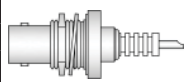
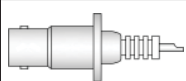
Connection Method	Product Image	Attachment Cable/Contact	Coax Type / Termination Type	Model No.	Price				ROW
					1-24	25-49	50-99	100 +	
Plug									
Cable Connectors		Crimp/Solder	RG58, RG303, RG141, PE-C195, PE-P195, LMR-195, .195 inch	PE4194	\$41.45	\$38.55	\$35.65	\$33.16	97
			RG59*, RG62*, RG71	PE4343	\$36.68	\$34.11	\$31.54	\$29.34	98
			RG214, RG9, RG225, RG393	PE4349	\$35.18	\$32.72	\$30.25	\$28.14	99
			RG213, RG8	PE4496	\$32.08	\$29.83	\$27.59	\$25.66	1
			RG55, RG141, RG142, RG223, RG400	PE4497	\$32.08	\$29.83	\$27.59	\$25.66	2
			RG59*, RG62*, RG71	PE4100	\$23.72	\$22.06	\$20.40	\$18.98	3
Cable Connectors		Clamp/Solder	RG58, RG55, RG141, RG142, RG223, RG400, RG303, PE-C195, PE-P195, LMR-195	PE4316	\$23.66	\$22.00	\$20.35	\$18.93	4
			RG8, RG213, RG214	PE4333	\$34.80	\$32.36	\$29.93	\$27.84	5
			RG174, RG316, RG188, LMR-100, PE-B100, PE-C100, .100 inch	PE4498	\$36.51	\$33.95	\$31.40	\$29.21	6
			Plug, Bulkhead Mount						
Terminal		Solder	Solder Cup with .350 inch D Hole	PE44118	\$45.32	\$42.15	\$38.98	\$36.26	7
Jack, Bulkhead Mount									
Cable Connectors		Clamp/Solder	RG59*, RG62*, RG71 with .480 inch D Hole	PE4315	\$44.16	\$41.07	\$37.98	\$35.33	8
			RG213, RG214, RG8, RG9, RG225, RG393, RG215 with .480 inch D Hole	PE44049	\$57.86	\$53.81	\$49.76	\$46.29	9
			RG58, RG142, RG223, RG400, RG141, RG303, RG55, LMR-400, PE-C195, PE-P195 with .480 inch D Hole	PE44080	\$44.16	\$41.07	\$37.98	\$35.33	10
			RG174, RG316, RG188 with .480 inch D Hole	PE44093	\$42.20	\$39.25	\$36.29	\$33.76	11
Terminal		Solder	Solder Cup with .350 inch D Hole	PE4239	\$20.51	\$19.07	\$17.64	\$16.41	12
			Solder Cup with .480 inch D Hole	PE4499	\$24.73	\$23.00	\$21.27	\$19.78	13
			Solder Cup with .350 inch D Hole	PE4500	\$59.99	\$55.79	\$51.59	\$47.99	14
Jack, 4 Hole Flange Mount									
Terminal		Solder	Solder Cup with .500 inch Hole Spacing	PE4501	\$34.03	\$31.65	\$29.27	\$27.22	15

* Fits MIL-C-17 and equivalent cable versions only



Free Shipping Available
via UPS Ground
to USA & Canada



Technical
Support
(866) 727-8376









Same-Day Shipping,
Even Custom
Cable Assemblies

SMA Connectors





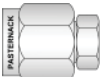



Connectors

See Our Website For Current Pricing & Real-Time Stock Availability!

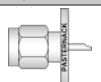
Connection Method	Product Image	Attachment Cable/Contact	Coax Type / Termination Type	Model No.	Price				ROW	
					1-24	25-49	50-99	100 +		
Cable Connectors	Male									
		Crimp/Crimp	RG174, RG316, RG188, LMR-100, PE-B100, PE-C100, .100 inch	PE4003	\$10.37	\$9.64	\$8.92	\$8.30	16	
		Crimp/Solder	RG55, RG142, RG223, RG400, RG141	PE4008	\$11.89	\$11.06	\$10.23	\$9.51	17	
			RG58, RG303, RG141, PE-C195, PE-P195, LMR-195, .195 inch	PE4215	\$10.83	\$10.07	\$9.31	\$8.66	18	
			RG59*, RG62*, RG71	PE4294	\$26.04	\$24.22	\$22.39	\$20.83	19	
			RG178, RG196	PE4398	\$18.18	\$16.91	\$15.63	\$14.54	20	
			RG188-DS, RG316-DS	PE4401	\$5.64	\$5.25	\$4.85	\$4.51	21	
			PE-P195	PE44203	\$16.70	\$15.53	\$14.36	\$13.36	22	
			PE-C195, PE-P195, RG58, RG141, RG303, LMR-195, .195 inch	PE44460	\$73.04	\$67.93	\$62.81	\$58.43	23	
			PE-C240, RG8X, .240 inch, LMR-240, LMR-240-DB, LMR-240-UF, B7808A	PE44637	\$19.54	\$18.17	\$16.80	\$15.63	24	
			PE-C400, PE-B400, PE-B405, LMR-400, LMR-400-DB, LMR-400-UF, .400 inch	PE44668	\$26.52	\$24.66	\$22.81	\$21.22	25	
			RG174, RG316, RG188	PE45145	\$8.82	\$8.20	\$7.59	\$7.06	26	
			PE-B150, RG180, RG195	PE4578	\$23.12	\$21.50	\$19.88	\$18.50	27	
			LMR-100, PE-C100, RG174, RG188, RG316	TC-100-SM	\$12.44	\$12.44	\$12.44	\$12.44	28	
				TC-195-SM-SS-X	\$15.74	\$15.74	\$15.74	\$15.74	29	
				TC-200-SM-SS-X	\$14.56	\$14.56	\$14.56	\$14.56	30	
		TC-240-SM-SS-X	\$9.81	\$9.81	\$9.81	\$9.81	31			
		TC-400-SM-X	\$24.98	\$24.98	\$24.98	\$24.98	32			
		Crimp/Solder (Captive Contact)	RG55, RG141, RG142, RG223, RG400	PE4576	\$24.06	\$22.38	\$20.69	\$19.25	33	
			RG58	PE4577	\$20.20	\$18.79	\$17.37	\$16.16	34	
			RG174, RG316, RG188, LMR-100, PE-B100, PE-C100, .100 inch	PE4589	\$17.17	\$15.97	\$14.77	\$13.74	35	
	PCB Mount		Clamp	Vertical Launch	PE45460	\$37.61	\$34.98	\$32.34	\$30.09	36
				Vertical Launch	PE45461	\$37.61	\$34.98	\$32.34	\$30.09	37
	Cable Connectors		Clamp/Solder	RG174, RG316, RG188, PE-B100, PE-C100, .100 inch, LMR-100	PE4026	\$26.91	\$25.03	\$23.14	\$21.53	38
				RG55, RG58, RG141, RG142, RG223, RG303, RG400, PE-C195, PE-P195, LMR-195	PE4027	\$26.59	\$24.73	\$22.87	\$21.27	39
				RG178, RG196	PE4214	\$48.00	\$44.64	\$41.28	\$38.40	40
				RG213, RG214, RG8, RG9, RG11*, RG225, RG393, RG144*, RG216*, RG215	PE4332	\$76.06	\$70.74	\$65.41	\$60.85	41
				RG180, RG195, PE-B150	PE4399	\$21.58	\$20.07	\$18.56	\$17.26	42
				RG188-DS, RG316-DS	PE4400	\$28.86	\$26.84	\$24.82	\$23.09	43
				RG316, RG174, LMR-100	PE45142	\$14.46	\$13.45	\$12.44	\$11.57	44
				PE-P160LL	PE45440	\$77.42	\$72.00	\$66.58	\$61.94	45
				PE-SR405AL, PE-SR405FL, RG405	PE4005	\$7.43	\$6.91	\$6.39	\$5.94	46
				RG174, RG316, RG188, LMR-100, PE-B100, PE-C100, .100 inch	PE4036	\$13.23	\$12.30	\$11.38	\$10.58	47
			Solder/Solder	RG58, RG55, RG142, RG223, RG400	PE4037	\$14.56	\$13.54	\$12.52	\$11.65	48
				PE-SR402AL, PE-SR402FL, PE-SR402FLJ, PE-SR402TN, RG402	PE4112	\$9.37	\$8.71	\$8.06	\$7.50	49
				RG178, RG196	PE4213	\$17.10	\$15.90	\$14.71	\$13.68	50
RG188-DS, RG316-DS				PE4402	\$15.21	\$14.15	\$13.08	\$12.17	51	
PE-047SR, PE-SR047AL, PE-SR047FL				PE4404	\$25.96	\$24.14	\$22.33	\$20.77	52	
PE-SR405AL, PE-SR405FL, PE-SR405FLJ, PE-SR405TN, RG405				PE44690	\$9.53	\$8.86	\$8.20	\$7.62	53	
PE-047SR, PE-SR047AL, PE-SR047FL				PE44757	\$33.60	\$31.25	\$28.90	\$26.88	54	
RG405, PE-SR405FL, PE-SR405FLJ				PE45135	\$7.04	\$6.55	\$6.05	\$5.63	55	
SPP-250-LLPL				PE45433	\$13.89	\$12.92	\$11.95	\$11.11	56	
PE-SR401AL, PE-SR401FL, RG401				PE4907	\$40.01	\$37.21	\$34.41	\$32.01	57	
PE-034SR				PE4917	\$74.27	\$69.07	\$63.87	\$59.42	58	
PE-020SR	PE4918	\$41.04	\$38.17	\$35.29	\$32.83	59				
	Solder (Without Contact)	PE-SR402AL, PE-SR402FL, PE-SR402FLJ, PE-SR402TN, RG402	PE4007	\$8.79	\$8.17	\$7.56	\$7.03	60		
		PE-SR402AL, PE-SR402FL, PE-SR402FLJ, PE-SR402TN, RG402	PE44691	\$8.72	\$8.11	\$7.50	\$6.98	61		

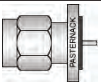
* Fits MIL-C-17 and equivalent cable versions only

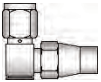
SMA Connectors

Connection Method	Product Image	Attachment Cable/Contact	Coax Type / Termination Type	Model No.	Price				ROW
					1-24	25-49	50-99	100 +	
Male									
PCB Mount		Solder	Thru Hole with .200 inch x .067 inch Hole Spacing	PE4525	\$21.17	\$19.69	\$18.21	\$16.94	62
			.062 inch End Launch	PE4912	\$29.05	\$27.02	\$24.98	\$23.24	63
			.062 inch End Launch	PE4913	\$29.29	\$27.24	\$25.19	\$23.43	64
Cable Connectors		Crimp/Non-Solder Contact	LMR-240, PE-C240	EZ-240-SM-X	\$9.14	\$9.14	\$9.14	\$9.14	65
Male, Bulkhead Mount									
Terminal		Solder	Solder Cup with .235 inch D Hole	PE4354	\$18.19	\$16.92	\$15.64	\$14.55	66
Male, 2 Hole Flange Mount									
Terminal		Solder	Stub with .481 inch Hole Spacing	PE4127	\$13.83	\$12.86	\$11.89	\$11.06	67
Field Replaceable		Field Replaceable	.018 inch Pin	PE44030	\$37.73	\$35.09	\$32.45	\$30.18	68
Male, 4 Hole Flange Mount									
Terminal		Solder	Stub with .340 inch Hole Spacing	PE4126	\$23.93	\$22.25	\$20.58	\$19.14	69
			Solder Cup with .340 inch Hole Spacing	PE45204	\$44.47	\$41.36	\$38.24	\$35.58	70
			Pin with .340 inch Hole Spacing	PE4541	\$48.46	\$45.07	\$41.68	\$38.77	71
Male Right Angle									
Cable Connectors		Crimp/Solder	RG55, RG142, RG223, RG400, RG141	PE4002	\$17.29	\$16.08	\$14.87	\$13.83	72
			RG174, RG316, RG188, LMR-100, PE-B100, PE-C100, .100 inch	PE4009	\$20.44	\$19.01	\$17.58	\$16.35	73
			RG178, RG196	PE4296	\$26.78	\$24.91	\$23.03	\$21.42	74
			RG59*, RG62*, RG71	PE4327	\$31.60	\$29.39	\$27.18	\$25.28	75
			RG58, RG303, RG141, PE-C195, PE-P195, LMR-195, .195 inch	PE4405	\$11.23	\$10.44	\$9.66	\$8.98	76
			RG188-DS, RG316-DS	PE4408	\$19.17	\$17.83	\$16.49	\$15.34	77
		Clamp/Solder	PE-C240, RG8X, .240 inch, LMR-240, LMR-240-DB, LMR-240-UF, B7808A	PE44638	\$26.81	\$24.93	\$23.06	\$21.45	78
			RG174, RG316, RG188, .100 inch, PE-B100, PE-C100, LMR-100	PE4028	\$30.70	\$28.55	\$26.40	\$24.56	79
			RG188-DS, RG316-DS	PE4407	\$34.86	\$32.42	\$29.98	\$27.89	80
			PE-SR402AL, PE-SR402FL, PE-SR402FLJ, PE-SR402TN, RG402	PE44996	\$82.56	\$76.78	\$71.00	\$66.05	81
			RG58, RG55, RG141, RG142, RG223, RG303, RG400, LMR-195, PE-C195	PE45048	\$47.31	\$44.00	\$40.69	\$37.85	82
			PE-P160LL	PE45442	\$113.13	\$105.21	\$97.29	\$90.50	83
		Solder/Solder	PE-SR405AL, PE-SR405FL, RG405	PE4025	\$28.47	\$26.48	\$24.48	\$22.78	84
			RG316, RG174, RG188, LMR-100, PE-B100, PE-C100, .100 inch	PE4038	\$18.49	\$17.20	\$15.90	\$14.79	85
			RG58, RG55, RG142, RG223, RG400	PE4039	\$17.10	\$15.90	\$14.71	\$13.68	86
			PE-SR402AL, PE-SR402FL, PE-SR402FLJ, PE-SR402TN, RG402	PE4083	\$20.41	\$18.98	\$17.55	\$16.33	87
			RG178, RG196	PE4406	\$22.81	\$21.21	\$19.62	\$18.25	88
			RG188-DS, RG316-DS	PE4409	\$21.37	\$19.87	\$18.38	\$17.10	89
			PE-SR405AL, PE-SR405FL, PE-SR405FLJ, PE-SR405TN, RG405	PE44692	\$11.57	\$10.76	\$9.95	\$9.26	90
			PE-SR402AL, PE-SR402FL, PE-SR402FLJ, PE-SR402TN, RG402	PE44693	\$11.16	\$10.38	\$9.60	\$8.93	91
			PE-047SR, PE-SR047AL, PE-SR047FL	PE45282	\$54.99	\$51.14	\$47.29	\$43.99	92
			SPP-250-LLPL	PE45434	\$15.29	\$14.22	\$13.15	\$12.23	93
			PE-034SR	PE4919	\$53.88	\$50.11	\$46.34	\$43.10	94
			PE-020SR	PE4920	\$59.76	\$55.58	\$51.39	\$47.81	95
PCB Mount		Solder	Thru Hole with .200 inch x .067 inch Hole Spacing	PE4526	\$36.20	\$33.67	\$31.13	\$28.96	97
			PE-SR401AL, PE-SR401FL, RG401	PE4932	\$54.74	\$50.91	\$47.08	\$43.79	96

Connectors

See Our Website For Current Pricing & Real-Time Stock Availability!

* Fits MIL-C-17 and equivalent cable versions only



Free Shipping Available via UPS Ground to USA & Canada











Technical Support (866) 727-8376

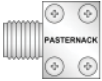

Same-Day Shipping, Even Custom Cable Assemblies

SMA Connectors













Connection Method	Product Image	Attachment Cable/Contact	Coax Type / Termination Type	Model No.	Price				ROW			
					1-24	25-49	50-99	100 +				
Cable Connectors	Male Right Angle											
		Crimp/Non-Solder Contact	LMR-240	EZ-240-SM-RA-X	\$13.09	\$13.09	\$13.09	\$13.09	98			
Cable Connectors	Female											
		Crimp/Solder	RG178, RG196	PE4325	\$26.59	\$24.73	\$22.87	\$21.27	99			
			RG55, RG142, RG223, RG400, RG141	PE4412	\$15.95	\$14.83	\$13.72	\$12.76	1			
			RG58	PE4413	\$17.90	\$16.65	\$15.39	\$14.32	2			
			RG174, RG316, RG188, .100 inch, PE-B100, PE-C100, LMR-100	PE4414	\$19.86	\$18.47	\$17.08	\$15.89	3			
			RG188-DS, RG316-DS	PE4416	\$17.90	\$16.65	\$15.39	\$14.32	4			
			PE-C240, RG8X, .240 inch, LMR-240, LMR-240-DB, LMR-240-UF, B7808A	PE44639	\$22.43	\$20.86	\$19.29	\$17.94	5			
			PE-C400, PE-B400, PE-B405, LMR-400, LMR-400-DB, LMR-400-UF, .400 inch	PE44669	\$43.25	\$40.22	\$37.20	\$34.60	6			
			RG316, RG174, LMR-100	PE45137	\$8.79	\$8.17	\$7.56	\$7.03	7			
Vertical Launch			PE45458	\$35.15	\$32.69	\$30.23	\$28.12	8				
PCB Mount		Clamp	Vertical Launch	PE45459	\$35.15	\$32.69	\$30.23	\$28.12	9			
Cable Connectors		Clamp/Solder	RG55, RG58, RG141, RG142, RG223, RG303, RG400, PE-C195, PE-P195, LMR-195	PE4031	\$40.37	\$37.54	\$34.72	\$32.30	10			
			RG213, RG214, RG8, RG9, RG11*, RG225, RG393	PE4411	\$56.47	\$52.52	\$48.56	\$45.18	11			
PCB Mount		Clamp/Solder (Captive Contact)	PE-P142LL	PE44814	\$60.73	\$56.48	\$52.23	\$48.58	12			
			End Launch	PE45462	\$50.06	\$46.56	\$43.05	\$40.05	13			
			End Launch	PE45463	\$50.06	\$46.56	\$43.05	\$40.05	14			
			End Launch	PE45464	\$50.06	\$46.56	\$43.05	\$40.05	15			
			End Launch	PE45465	\$50.06	\$46.56	\$43.05	\$40.05	16			
Cable Connectors		Solder/Solder	RG316, RG174, RG188	PE4040	\$14.21	\$13.22	\$12.22	\$11.37	18			
			RG58, RG55, RG142, RG223, RG400	PE4041	\$15.63	\$14.54	\$13.44	\$12.50	19			
			PE-SR402AL, PE-SR402FL, PE-SR402FLJ, PE-SR402TN, RG402	PE4115	\$14.69	\$13.66	\$12.63	\$11.75	20			
			PE-SR405AL, PE-SR405FL, PE-SR405FLJ, RG405	PE4116	\$22.88	\$21.28	\$19.68	\$18.30	21			
			PE-047SR, PE-SR047AL, PE-SR047FL	PE4418	\$34.72	\$32.29	\$29.86	\$27.78	22			
			PE-SR405AL, PE-SR405FL, PE-SR405FLJ, PE-SR405TN, RG405	PE44694	\$8.20	\$7.63	\$7.05	\$6.56	23			
			PE-SR402AL, PE-SR402FL, PE-SR402FLJ, PE-SR402TN, RG402	PE44695	\$8.20	\$7.63	\$7.05	\$6.56	24			
			SPP-250-LLPL	PE45432	\$14.59	\$13.57	\$12.55	\$11.67	25			
			RG178, RG196	PE4592	\$21.42	\$19.92	\$18.42	\$17.14	26			
			PE-034SR	PE4921	\$53.88	\$50.11	\$46.34	\$43.10	27			
			PE-020SR	PE4922	\$58.70	\$54.59	\$50.48	\$46.96	28			
			PE-SR401AL, PE-SR401FL, RG401	PE4930	\$24.93	\$23.18	\$21.44	\$19.94	29			
			PCB Mount		Solder/Solder (Captive Contact)	1/8 inch Stripline	PE4190	\$44.81	\$41.67	\$38.54	\$35.85	30
						1/16 inch Stripline	PE4534	\$42.59	\$39.61	\$36.63	\$34.07	31
					Solder	Thru Hole with .200 inch x .067 inch Hole Spacing	PE4117	\$13.06	\$12.15	\$11.23	\$10.45	32
						.042 inch End Launch	PE44204	\$22.65	\$21.06	\$19.48	\$18.12	33
						.047 inch End Launch	PE44205	\$25.89	\$24.08	\$22.27	\$20.71	34
.031 inch End Launch	PE44206	\$18.63				\$17.33	\$16.02	\$14.90	35			
.042 inch End Launch	PE44207	\$24.17				\$22.48	\$20.79	\$19.34	36			
.047 inch End Launch	PE44208	\$25.16				\$23.40	\$21.64	\$20.13	37			
End Launch	PE44235	\$20.43				\$19.00	\$17.57	\$16.34	38			
Thru Hole with .200 inch x .067 inch Hole Spacing	PE44342	\$50.20				\$46.69	\$43.17	\$40.16	39			
.078 inch End Launch	PE44614	\$30.87	\$28.71	\$26.55	\$24.70	40						
Thru Hole with .200 inch x .067 inch Hole Spacing	PE44827	\$9.49	\$8.83	\$8.16	\$7.59	41						
.062 inch End Launch	PE4542	\$18.03	\$16.77	\$15.51	\$14.42	42						
.062 inch End Launch	PE4543	\$18.43	\$17.14	\$15.85	\$14.74	43						
Surface Mount	PE4910	\$16.36	\$15.21	\$14.07	\$13.09	44						
Cable Connectors	Female, Bulkhead Mount											
		Crimp/Solder	RG55, RG142, RG223, RG400, RG141 with .235 inch D Hole	PE4419	\$20.03	\$18.63	\$17.23	\$16.02	45			
			RG58 with .235 inch D Hole	PE4420	\$17.42	\$16.20	\$14.98	\$13.94	46			
			RG316, RG174, RG188, PE-B100, PE-C100, .100 inch, LMR-100 with .235 inch D Hole	PE4427	\$15.89	\$14.78	\$13.67	\$12.71	47			
			RG174, RG316, RG188, .100 inch, PE-B100, PE-C100, LMR-100 with .235 inch D Hole	PE44643	\$22.52	\$20.94	\$19.37	\$18.02	48			
RG316, RG174, LMR-100			PE45136	\$12.05	\$11.21	\$10.36	\$9.64	49				

* Fits MIL-C-17 and equivalent cable versions only

Connectors

See Our Website For Current Pricing & Real-Time Stock Availability!

SMA Connectors

Connection Method	Product Image	Attachment Cable/Contact	Coax Type / Termination Type	Model No.	Price				ROW
					1-24	25-49	50-99	100 +	
Female, Bulkhead Mount									
Cable Connectors		Crimp/Solder	RG58, RG303, LMR-195, PE-P195	PE45141	\$12.48	\$11.61	\$10.73	\$9.98	50
			RG178, RG196 with .235 inch D Hole	PE45292	\$19.75	\$18.37	\$16.99	\$15.80	51
PCB Mount			Thru Hole	PE45134	\$23.25	\$21.62	\$20.00	\$18.60	52
Cable Connectors		Clamp/Solder	RG188-DS, RG316-DS with .235 inch D Hole	PE4424	\$37.59	\$34.96	\$32.33	\$30.07	53
			PE-P160LL	PE45441	\$93.78	\$87.22	\$80.65	\$75.02	54
Cable Connectors		Solder/Solder	PE-SR405AL, PE-SR405FL, RG405 with .235 inch D Hole	PE4119	\$12.37	\$11.50	\$10.64	\$9.90	55
			PE-SR402AL, PE-SR402FL, PE-SR402FLJ, PE-SR402TN, RG402 with .235 inch D Hole	PE4120	\$15.08	\$14.02	\$12.97	\$12.06	56
			RG316, RG174, RG188 with .235 inch D Hole	PE4188	\$17.10	\$15.90	\$14.71	\$13.68	57
			RG58, RG55, RG142, RG223, RG400 with .235 inch D Hole	PE4353	\$17.53	\$16.30	\$15.08	\$14.02	58
Cable Connectors		Solder/Solder	PE-SR405AL, PE-SR405FL, PE-SR405FLJ, PE-SR405TN, RG405	PE44696	\$11.90	\$11.07	\$10.23	\$9.52	59
			.042 inch End Launch with .250 inch Diameter	PE44211	\$24.56	\$22.84	\$21.12	\$19.65	60
			.062 inch End Launch with .250 inch Diameter	PE44212	\$24.11	\$22.42	\$20.73	\$19.29	61
			.062 inch End Launch with .250 inch Diameter	PE44214	\$24.11	\$22.42	\$20.73	\$19.29	62
Terminal		Solder	Thru Hole with .235 inch D Hole	PE4524	\$17.64	\$16.41	\$15.17	\$14.11	63
			Solder Cup with .235 inch D Hole	PE4101	\$16.33	\$15.19	\$14.04	\$13.06	64
			Stub with .250 inch Diameter	PE4189	\$14.43	\$13.42	\$12.41	\$11.54	65
			Solder Cup with .235 inch D Hole	PE4219	\$13.01	\$12.10	\$11.19	\$10.41	66
			Stub with .250 inch Diameter	PE44591	\$26.52	\$24.66	\$22.81	\$21.22	67
			Stub with .235 inch D Hole	PE4528	\$32.49	\$30.22	\$27.94	\$25.99	68
			Solder Cup with .235 inch D Hole	PE4529	\$24.43	\$22.72	\$21.01	\$19.54	69
			Stub with .250 inch Diameter	PE4530	\$31.71	\$29.49	\$27.27	\$25.37	70
			Stub with .250 inch Diameter	PE4532	\$25.92	\$24.11	\$22.29	\$20.74	71
			Solder Cup with .350 inch D Hole	PE4536	\$37.60	\$34.97	\$32.34	\$30.08	72
Solder Cup with .250 inch Diameter	PE4549	\$25.40	\$23.62	\$21.84	\$20.32	73			
Female, 2 Hole Flange Mount									
Cable Connectors		Solder/Solder	PE-SR402AL, PE-SR402FL, RG402 with .481 inch Hole Spacing	PE4196	\$26.19	\$24.36	\$22.52	\$20.95	74
			PE-SR405AL, PE-SR405FL, PE-SR405FLJ, RG405 with .481 inch Hole Spacing	PE4197	\$22.45	\$20.88	\$19.31	\$17.96	75
			PE-047SR, PE-SR047AL, PE-SR047FL with .481 inch Hole Spacing	PE4547	\$26.05	\$24.23	\$22.40	\$20.84	76
Terminal		Solder	Solder Cup with .481 inch Hole Spacing	PE4004	\$15.27	\$14.20	\$13.13	\$12.22	77
			Stub with .481 inch Hole Spacing	PE4128	\$17.85	\$16.60	\$15.35	\$14.28	78
			Stub with .481 inch Hole Spacing	PE4128-SF	Call	Call	Call	Call	79
			Solder Cup with .481 inch Hole Spacing	PE44341	\$54.33	\$50.53	\$46.72	\$43.46	80
			Stub with .481 inch Hole Spacing	PE44343	\$51.13	\$47.55	\$43.97	\$40.90	81
			Stub	PE45039	\$12.11	\$11.26	\$10.41	\$9.69	82
Field Replaceable		Field Replaceable	.015 inch Pin	PE44024	\$31.98	\$29.74	\$27.50	\$25.58	84
			.018 inch Pin	PE44025	\$32.74	\$30.45	\$28.16	\$26.19	85
			.020 inch Pin	PE45054	\$27.06	\$25.17	\$23.27	\$21.65	86
			.036 inch Pin	PE45055	\$27.49	\$25.57	\$23.64	\$21.99	87
Terminal		Compression	Stub with .481 inch Hole Spacing	PE44340	\$60.88	\$56.62	\$52.36	\$48.70	88
Female, 4 Hole Flange Mount									
Cable Connectors		Solder/Solder	RG402, RG402 Tinned, PE-SR402FL, PE-SR402AL, PE-SR402FLJ, PE-SR402TN with .340 inch Hole Spacing	PE4121	\$33.39	\$31.05	\$28.72	\$26.71	89
			RG405, RG405 Tinned, PE-SR405FL, PE-SR405AL, PE-SR405FLJ, PE-SR405TN	PE44998	\$29.51	\$27.44	\$25.38	\$23.61	90
Terminal		Solder	Solder Cup with .340 inch Hole Spacing	PE4000	\$20.13	\$18.72	\$17.31	\$16.10	91
			Stub with .340 inch Hole Spacing	PE4099	\$16.02	\$14.90	\$13.78	\$12.82	92
			Tab with .340 inch Hole Spacing	PE4186	\$17.13	\$15.93	\$14.73	\$13.70	93
			Pin with .340 inch Hole Spacing	PE4217	\$22.74	\$21.15	\$19.56	\$18.19	94
			Solder Cup with .718 inch Hole Spacing	PE4218	\$24.38	\$22.67	\$20.97	\$19.50	95
			Stub with .500 inch Hole Spacing	PE4533	\$23.66	\$22.00	\$20.35	\$18.93	96
Pin with .340 inch Hole Spacing	PE4540	\$45.96	\$42.74	\$39.53	\$36.77	97			

Connectors

See Our Website For Current Pricing & Real-Time Stock Availability!

* Fits MIL-C-17 and equivalent cable versions only



Free Shipping Available via UPS Ground to USA & Canada









Technical Support (866) 727-8376



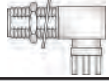



Same-Day Shipping, Even Custom Cable Assemblies

SMA Connectors

Connection Method	Product Image	Attachment Cable/Contact	Coax Type / Termination Type	Model No.	Price				ROW
					1-24	25-49	50-99	100 +	
Female, 4 Hole Flange Mount									
Field Replaceable		Field Replaceable	.020 inch Pin	PE44003	\$31.90	\$29.67	\$27.43	\$25.52	98
			.036 inch Pin	PE44004	\$34.11	\$31.72	\$29.33	\$27.29	99
			.020 inch Pin	PE45215	\$17.57	\$16.34	\$15.11	\$14.06	1
			.015 inch Pin	PE45216	\$16.36	\$15.21	\$14.07	\$13.09	2
Female, Press-In									
Terminal		Solder	Tab with .200 inch Diameter	PE44241	\$30.61	\$28.47	\$26.32	\$24.49	3
Female Right Angle									
PCB Mount		Solder	Thru Hole with .200 inch x .067 inch Hole Spacing	PE4118	\$18.98	\$17.65	\$16.32	\$15.18	4
			Surface Mount	PE4911	\$25.20	\$23.44	\$21.67	\$20.16	5
Female Right Angle, Bulkhead Mount									
PCB Mount		Solder	Thru Hole with .235 inch D Hole	PE4545	\$27.78	\$25.84	\$23.89	\$22.22	6
Female Right Angle, 2 Hole Flange Mount									
Terminal		Solder	Pin with .481 inch Hole Spacing	PE44237	\$51.38	\$47.78	\$44.19	\$41.10	7
			Pin with .481 inch Hole Spacing	PE44238	\$45.66	\$42.46	\$39.27	\$36.53	8
			Pin with .481 inch Hole Spacing	PE44239	\$44.61	\$41.49	\$38.36	\$35.69	9
			Pin with .481 inch Hole Spacing	PE44593	\$45.66	\$42.46	\$39.27	\$36.53	10
Female Right Angle, 4 Hole Flange Mount									
Terminal		Solder	Solder Cup with .340 inch Hole Spacing	PE4123	\$36.89	\$34.31	\$31.73	\$29.51	11
			Pin with .340 inch Hole Spacing	PE44236	\$30.61	\$28.47	\$26.32	\$24.49	12
Field Replaceable		Field Replaceable	.018 inch Pin	PE44017	\$66.46	\$61.81	\$57.16	\$53.17	13

Reverse Polarity SMA Connectors





Connection Method	Product Image	Attachment Cable/Contact	Coax Type / Termination Type	Model No.	Price				ROW
					1-24	25-49	50-99	100 +	
Male									
Cable Connectors		Crimp/Solder	PE-C240, RG8X, .240 inch, LMR-240, LMR-240-DB, LMR-240-UF, B7808A	PE44664	\$24.89	\$23.15	\$21.41	\$19.91	14
			PE-C400, PE-B400, PE-B405, LMR-400, LMR-400-DB, LMR-400-UF, .400 inch	PE44666	\$24.72	\$22.99	\$21.26	\$19.78	15
			RG55, RG141, RG142, RG223, RG400	PE4767	\$19.80	\$18.41	\$17.03	\$15.84	16
			RG58	PE4769	\$20.63	\$19.19	\$17.74	\$16.50	17
			RG174, RG316, RG188, PE-B100, PE-C100, .100 inch, LMR-100	PE4771	\$18.79	\$17.47	\$16.16	\$15.03	18
Cable Connectors		Clamp/Solder	RG55, RG58, RG141, RG142, RG223, RG303, RG400, PE-C195, PE-P195, LMR-195	PE4766	\$32.44	\$30.17	\$27.90	\$25.95	19
			PE-SR405AL, PE-SR405FL, RG405	PE4779	\$24.38	\$22.67	\$20.97	\$19.50	20
Male Right Angle									
Cable Connectors		Crimp/Solder	RG58, RG141, PE-C195, PE-P195	PE45012	Call	Call	Call	Call	21
			RG174, RG316, RG188, PE-B100, PE-C100, .100 inch, LMR-100	PE4785	\$49.41	\$45.95	\$42.49	\$39.53	22
			RG55, RG141, RG142, RG223, RG400	PE44975	\$35.58	\$33.09	\$30.60	\$28.46	23
			RG58, RG55, RG141, RG142, RG223, RG400	PE4782	\$33.83	\$31.46	\$29.09	\$27.06	24
Cable Connectors		Solder/Solder	RG174, RG316, RG188	PE4786	\$33.83	\$31.46	\$29.09	\$27.06	25

* Fits MIL-C-17 and equivalent cable versions only



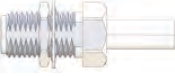
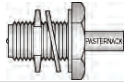

Connectors

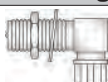
See Our Website For Current Pricing & Real-Time Stock Availability!

Reverse Polarity SMA Connectors

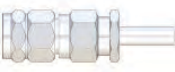
Connection Method	Product Image	Attachment Cable/Contact	Coax Type / Termination Type	Model No.	Price				ROW
					1-24	25-49	50-99	100 +	
Female									
Cable Connectors		Crimp/Solder	PE-C240, RG8X, .240 inch, LMR-240, LMR-240-DB, LMR-240-UF, B7808A	PE44665	\$26.77	\$24.90	\$23.02	\$21.42	26
			RG188-DS, RG316-DS	PE45186	\$26.00	\$24.18	\$22.36	\$20.80	27
			RG58	PE4795	\$24.87	\$23.13	\$21.39	\$19.90	28
PCB Mount		Solder	Thru Hole with .200 inch x .067 inch Hole Spacing	PE4869	\$21.93	\$20.39	\$18.86	\$17.54	29
Female, Bulkhead Mount									
Cable Connectors		Crimp/Solder	RG196, RG178	PE45004	\$13.05	\$12.14	\$11.22	\$10.44	30
			.100 inch, RG316, RG174, RG188, LMR-100, LMR-100A, LMR-100A-FR, PE-C100, PE-B100 with .235 inch D Hole	PE4859	\$26.07	\$24.25	\$22.42	\$20.86	31
		Clamp/Solder	RG174, RG316, RG188 with .235 inch D Hole	PE4858	\$37.73	\$35.09	\$32.45	\$30.18	32
		Solder/Solder	PE-SR405AL, PE-SR405FL, PE-SR405FLJ, PE-SR405TN, RG405 with .235 inch D Hole	PE4865	\$35.85	\$33.34	\$30.83	\$28.68	33
Female, 2 Hole Flange Mount									
Terminal		Solder	Solder Cup with .481 inch Hole Spacing	PE4867	\$26.11	\$24.28	\$22.45	\$20.89	34
Female Right Angle									
PCB Mount		Solder	Thru Hole with .200 inch x .067 inch Hole Spacing	PE4870	\$32.59	\$30.31	\$28.03	\$26.07	35
Female Right Angle, Bulkhead Mount									
PCB Mount		Solder	Thru Hole with .250 inch Diameter	PE4875	\$43.64	\$40.59	\$37.53	\$34.91	36

Reverse Thread SMA Connectors

Connection Method	Product Image	Attachment Cable/Contact	Coax Type / Termination Type	Model No.	Price				ROW
					1-24	25-49	50-99	100 +	
Male									
Cable Connectors		Crimp/Solder	RG178, RG196	PE44185	\$24.38	\$22.67	\$20.97	\$19.50	37
Male Right Angle									
Cable Connectors		Crimp/Solder	RG174, RG316, RG188	PE44188	\$42.39	\$39.42	\$36.46	\$33.91	38
Female									
Cable Connectors		Crimp/Solder	RG174, RG316, RG188	PE44192	\$25.64	\$23.85	\$22.05	\$20.51	39
PCB Mount		Solder	Thru Hole with .200 inch x .067 inch Hole Spacing	PE44198	\$27.69	\$25.75	\$23.81	\$22.15	40
			.062 inch End Launch	PE44201	\$27.69	\$25.75	\$23.81	\$22.15	41
			.062 inch End Launch	PE44202	\$27.69	\$25.75	\$23.81	\$22.15	42
Female, Bulkhead Mount									
Cable Connectors		Crimp/Solder	.100 inch, RG316, RG174, RG188, LMR-100, LMR-100A, LMR-100A-FR, PE-C100, PE-B100 with .235 inch D Hole	PE44196	\$19.98	\$18.58	\$17.18	\$15.98	43

* Fits MIL-C-17 and equivalent cable versions only



Free Shipping Available
via UPS Ground to
USA & Canada



Technical Support
(866) 727-8376



Same-Day Shipping,
Even Custom
Cable Assemblies

Connectors

See Our Website For Current Pricing & Real-Time Stock Availability!

SMA, 2.92mm Torque Wrenches



Type	Bit Hex Size (in.)	Preset Torque (in.-lbs.)	Model No	1-24	25-49	50-99	100+	ROW
SMA, 2.92mm	5/16 inch	5 in-lbs	PE5019-19	\$211.79	\$196.96	\$182.14	\$169.43	
		8 in-lbs	PE5011-1	\$213.26	\$198.33	\$183.40	\$170.61	

SMB Connectors





Connection Method	Product Image	Attachment Cable/Contact	Coax Type / Termination Type	Model No.	Price				ROW
					1-24	25-49	50-99	100 +	
Cable Connectors	Plug								
		Crimp/Solder	RG174, RG316, RG188, LMR-100, PE-B100, PE-C100, .100 inch	PE4046	\$12.10	\$11.25	\$10.41	\$9.68	44
			RG178, RG196	PE4080	\$16.52	\$15.36	\$14.21	\$13.22	45
			RG316-DS, RG188-DS	PE44792	\$13.02	\$12.11	\$11.20	\$10.42	46
			RG58, RG303, RG141, PE-C195, PE-P195, LMR-195, .195 inch	PE4523	\$17.47	\$16.25	\$15.02	\$13.98	47
			RG55, RG142, RG223, RG400	PE4593	\$15.96	\$14.84	\$13.73	\$12.77	48
		Clamp/Solder	RG174, RG316, RG188, .100 inch, PE-B100, PE-C100, LMR-100	PE4200	\$15.49	\$14.41	\$13.32	\$12.39	49
			RG178, RG196	PE4250	\$20.05	\$18.65	\$17.24	\$16.04	50
			PE-SR405AL, PE-SR405FL, RG405	PE4356	\$13.11	\$12.19	\$11.27	\$10.49	51
	Solder/Solder	RG405, PE-SR405FL, PE-SR405FLJ	PE45119	\$8.32	\$7.74	\$7.16	\$6.66	52	
PCB Mount		Solder	Thru Hole with .200 inch x .067 inch Hole Spacing	PE4366	\$22.53	\$20.95	\$19.38	\$18.02	53
Terminal		Solder	Solder Cup with .177 inch D Hole	PE4288	\$28.11	\$26.14	\$24.17	\$22.49	54
Cable Connectors	Plug Right Angle								
		Crimp/Solder	RG174, RG316, RG188, LMR-100, PE-B100, PE-C100, .100 inch	PE4052	\$9.33	\$8.68	\$8.02	\$7.46	55
			RG178, RG196	PE4159	\$18.31	\$17.03	\$15.75	\$14.65	56
			RG58, RG303, RG141, PE-C195, PE-P195, LMR-195, .195 inch	PE4522	\$20.73	\$19.28	\$17.83	\$16.58	57
			RG55, RG142, RG223, RG400	PE4595	\$18.93	\$17.60	\$16.28	\$15.14	58
	Clamp/Solder	PE-SR405AL, PE-SR405FL, PE-SR405FLJ, PE-SR405TN, RG405	PE4358	\$17.17	\$15.97	\$14.77	\$13.74	59	
Cable Connectors	Jack								
		Crimp/Solder	RG174, RG316, RG188, LMR-100, PE-B100, PE-C100, .100 inch	PE4096	\$13.73	\$12.77	\$11.81	\$10.98	60
			RG178, RG196	PE4926	\$24.56	\$22.84	\$21.12	\$19.65	61
		Clamp/Solder	RG178, RG196	PE4269	\$25.68	\$23.88	\$22.08	\$20.54	62
PE-SR405AL, PE-SR405FL, RG405			PE4360	\$16.26	\$15.12	\$13.98	\$13.01	63	
PCB Mount		Solder	Thru Hole with .200 inch x .067 inch Hole Spacing	PE4174	\$6.64	\$6.18	\$5.71	\$5.31	64
			Surface Mount	PE44119	\$8.60	\$8.00	\$7.40	\$6.88	65

* Fits MIL-C-17 and equivalent cable versions only



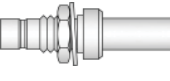
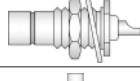

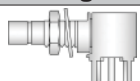

Connectors

See Our Website For Current Pricing & Real-Time Stock Availability!

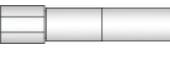
SMB Connectors

Connection Method	Product Image	Attachment Cable/Contact	Coax Type / Termination Type	Model No.	Price				ROW
					1-24	25-49	50-99	100 +	
Jack, Bulkhead Mount									
Cable Connectors		Crimp/Solder	RG174, RG316, RG188, LMR-100, PE-B100, PE-C100, .100 inch	PE4097	\$15.63	\$14.54	\$13.44	\$12.50	66
			RG178, RG196	PE4364	\$14.83	\$13.79	\$12.75	\$11.86	67
			RG55, RG141, RG142, RG223, RG400 with .177 inch D Hole	PE44048	\$30.81	\$28.65	\$26.50	\$24.65	68
			RG58	PE44094	\$25.77	\$23.97	\$22.16	\$20.62	69
Terminal		Solder	Solder Cup with .177 inch D Hole	PE4167	\$6.83	\$6.35	\$5.87	\$5.46	70
			Solder Cup with .177 inch D Hole	PE4170	\$13.76	\$12.80	\$11.83	\$11.01	71
PCB Mount			Thru Hole with .177 inch D Hole	PE44123	\$18.46	\$17.17	\$15.88	\$14.77	72
Jack, 4 Hole Flange Mount									
Terminal		Solder	Solder Cup with .232 inch Hole Spacing	PE44142	\$24.38	\$22.67	\$20.97	\$19.50	73
Jack Right Angle									
PCB Mount		Solder	Thru Hole with .200 inch x .067 inch Hole Spacing	PE4177	\$11.10	\$10.32	\$9.55	\$8.88	74
			Surface Mount	PE44121	\$20.44	\$19.01	\$17.58	\$16.35	75
Jack Right Angle, Bulkhead Mount									
PCB Mount		Solder	Thru Hole with .177 inch D Hole	PE44875	\$18.98	\$17.65	\$16.32	\$15.18	76

SMC Connectors

Connection Method	Product Image	Attachment Cable/Contact	Coax Type / Termination Type	Model No.	Price				ROW
					1-24	25-49	50-99	100 +	
Plug									
Cable Connectors		Crimp/Solder	RG174, RG316, RG188, LMR-100, PE-B100, PE-C100, .100 inch	PE4045	\$12.07	\$11.23	\$10.38	\$9.66	77
			RG178, RG196	PE4074	\$16.93	\$15.74	\$14.56	\$13.54	78
			RG188-DS, RG316-DS	PE45155	\$11.08	\$10.30	\$9.53	\$8.86	79
			PE-P195, PE-C195, RG58, RG141, RG303, .195 inch, LMR-195	PE4558	\$21.63	\$20.12	\$18.60	\$17.30	80
		Clamp/Solder	RG174, RG316, RG188, LMR-100, PE-B100, PE-C100, .100 inch	PE4201	\$13.00	\$12.09	\$11.18	\$10.40	81
Plug Right Angle									
Cable Connectors		Crimp/Solder	RG174, RG316, RG188, LMR-100, PE-B100, PE-C100, .100 inch	PE4051	\$16.93	\$15.74	\$14.56	\$13.54	82
			RG178, RG196	PE4160	\$16.01	\$14.89	\$13.77	\$12.81	83
PCB Mount		Solder	Thru Hole with .200 inch x .067 inch Hole Spacing	PE4246	\$40.79	\$37.93	\$35.08	\$32.63	84
Jack									
Cable Connectors		Crimp/Solder	RG174, RG316, RG188, LMR-100, PE-B100, PE-C100, .100 inch	PE4094	\$16.57	\$15.41	\$14.25	\$13.26	85
			RG188-DS, RG316-DS	PE45156	\$14.81	\$13.77	\$12.74	\$11.85	86
PCB Mount		Solder	Thru Hole with .200 inch x .067 inch Hole Spacing	PE4175	\$8.65	\$8.04	\$7.44	\$6.92	87
			Surface Mount	PE44120	\$16.22	\$15.08	\$13.95	\$12.98	88
			.062 inch End Launch	PE44130	\$48.91	\$45.49	\$42.06	\$39.13	89
Jack, Bulkhead Mount									
Cable Connectors		Crimp/Solder	RG174, RG316, RG188, LMR-100, PE-B100, PE-C100, .100 inch with .177 inch D Hole	PE4095	\$15.63	\$14.54	\$13.44	\$12.50	90
			RG58	PE44095	\$24.87	\$23.13	\$21.39	\$19.90	91

* Fits MIL-C-17 and equivalent cable versions only



Free Shipping Available via UPS Ground to USA & Canada



Technical Support (866) 727-8376





Same-Day Shipping, Even Custom Cable Assemblies



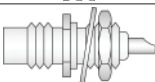
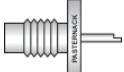

Connectors

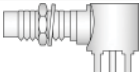
See Our Website For Current Pricing & Real-Time Stock Availability!

SMC Connectors

Connection Method	Product Image	Attachment Cable/Contact	Coax Type / Termination Type	Model No.	Price				ROW
					1-24	25-49	50-99	100 +	
PCB Mount		Solder	Thru Hole with .177 inch D Hole	PE44124	\$29.20	\$27.16	\$25.11	\$23.36	92
Terminal			Solder Cup with .177 inch D Hole	PE4107	\$12.73	\$11.84	\$10.95	\$10.18	93
			Solder Cup with .177 inch D Hole	PE4171	\$12.07	\$11.23	\$10.38	\$9.66	94
Jack, 4 Hole Flange Mount									
Terminal		Solder	Solder Cup with .232 inch Hole Spacing	PE44143	\$20.05	\$18.65	\$17.24	\$16.04	95
Jack Right Angle									
PCB Mount		Solder	Thru Hole with .200 inch x .067 inch Hole Spacing	PE4178	\$14.58	\$13.56	\$12.54	\$11.66	96
Jack Right Angle, Bulkhead Mount									
PCB Mount		Solder	Thru Hole with .177 inch D Hole	PE44127	\$22.44	\$20.87	\$19.30	\$17.95	97

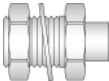
SMP Connectors





Connection Method	Product Image	Attachment Cable/Contact	Coax Type / Termination Type	Model No.	Price				ROW
					1-24	25-49	50-99	100 +	
Male									
PCB Mount		Solder	Thru Hole with .100 inch x .031 inch Hole Spacing	PE44348	\$30.24	\$28.12	\$26.01	\$24.19	98
			Thru Hole	PE44480	\$31.72	\$29.50	\$27.28	\$25.38	99
			Surface Mount	PE44481	\$33.30	\$30.97	\$28.64	\$26.64	1
			End Launch	PE44482	\$24.34	\$22.64	\$20.93	\$19.47	2
			Thru Hole	PE44840	\$9.81	\$9.12	\$8.44	\$7.85	3
			End Launch	PE44879	\$12.59	\$11.71	\$10.83	\$10.07	4
			Thru Hole	PE44910	\$32.45	\$30.18	\$27.91	\$25.96	5
			Thru Hole	PE44936	\$36.71	\$34.14	\$31.57	\$29.37	6
			Surface Mount	PE44944	\$51.32	\$47.73	\$44.14	\$41.06	7
			Surface Mount	PE44946	\$28.46	\$26.47	\$24.48	\$22.77	8
			Surface Mount	PE44947	\$79.43	\$73.87	\$68.31	\$63.54	9
			Edge Launch	PE44955	\$31.08	\$28.90	\$26.73	\$24.86	10
			Thru Hole	PE44957	\$41.95	\$39.01	\$36.08	\$33.56	11
			Thru Hole	PE44965	\$29.70	\$27.62	\$25.54	\$23.76	12
Terminal		Solder	Surface Mount	PE45278 TR1	\$34.67	\$32.24	\$29.82	\$27.74	13
			Surface Mount	PE45278 TR1500	Call	Call	Call	Call	14
Terminal		Solder	Pin	PE44779	\$19.74	\$18.36	\$16.98	\$15.79	15
			Pin	PE44780	\$20.11	\$18.70	\$17.29	\$16.09	16
Male, Bulkhead Mount									
Cable Connectors		Solder/Solder	RG405, RG405 Tinned, PE-SR405FL, PE-SR405AL, PE-SR405FLJ, PE-SR405TN with 4.83 mm Diameter	PE44483	\$39.15	\$36.41	\$33.67	\$31.32	17
			PE-SR405AL, PE-SR405FL, PE-SR405FLJ, PE-SR405TN, RG405	PE44961	\$35.40	\$32.92	\$30.44	\$28.32	18
			RG405, PE-SR405FL, PE-SR405FLJ	PE45126	\$31.83	\$29.60	\$27.37	\$25.46	19
Male, 2 Hole Flange Mount									
Cable Connectors		Solder/Solder	RG405, PE-SR405FL, PE-SR405FLJ	PE45127	\$33.82	\$31.45	\$29.09	\$27.06	20
Male, Thread-In									
Shroud		None	None	PE44906	\$22.90	\$21.30	\$19.69	\$18.32	21

* Fits MIL-C-17 and equivalent cable versions only

Connectors

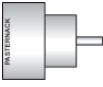
See Our Website For Current Pricing & Real-Time Stock Availability!

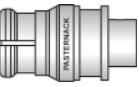
SMP Connectors

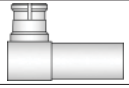
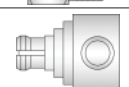
Connection Method	Product Image	Attachment Cable/Contact	Coax Type / Termination Type	Model No.	Price				ROW
					1-24	25-49	50-99	100 +	
Terminal		Solder	Pin	PE44909	\$39.88	\$37.09	\$34.30	\$31.90	22
			Pin	PE44931	\$49.75	\$46.27	\$42.78	\$39.80	23
			Pin	PE44956	\$69.41	\$64.55	\$59.69	\$55.53	24
			Pin	PE44963	\$38.22	\$35.54	\$32.87	\$30.58	25
Terminal		Solder	Male, Solder						
			Pin	PE44918	\$32.58	\$30.30	\$28.02	\$26.06	26
			Pin	PE44921	\$28.85	\$26.83	\$24.81	\$23.08	27
			Pin	PE44922	\$33.48	\$31.14	\$28.79	\$26.78	28
			Pin	PE44924	\$31.95	\$29.71	\$27.48	\$25.56	29
Pin	PE44926	\$30.91	\$28.75	\$26.58	\$24.73	30			
PCB Mount		Solder	Male Right Angle						
			Thru Hole	PE44934	\$56.49	\$52.54	\$48.58	\$45.19	31
Cable Connectors		Solder/Solder	Female						
			PE-047SR, PE-SR047AL, PE-SR047FL	PE44785	\$21.80	\$20.27	\$18.75	\$17.44	32
			PE-SR405AL, PE-SR405FL, PE-SR405FLJ, PE-SR405TN, RG405	PE44786	\$21.80	\$20.27	\$18.75	\$17.44	33
			RG405, PE-SR405AL, PE-SR405FL, PE-SR405FLJ	PE45285	\$8.42	\$7.83	\$7.24	\$6.74	34
	RG178, RG196	PE45287	\$8.36	\$7.77	\$7.19	\$6.69	35		
PCB Mount		Solder	Female Right Angle						
			Thru Hole	PE45277	\$4.26	\$3.96	\$3.66	\$3.41	36
Cable Connectors		Crimp/Crimp	Female Right Angle						
			RG178, RG196	PE45290	\$9.22	\$8.57	\$7.93	\$7.38	38
			RG316, RG174, LMR-100	PE45128	\$14.23	\$13.23	\$12.24	\$11.38	39
			PE-SR405AL, PE-SR405FL, PE-SR405FLJ, PE-SR405TN, RG405	PE44275	\$30.34	\$28.22	\$26.09	\$24.27	40
	PE-047SR, PE-SR047FL, PE-SR047AL	PE44911	\$32.40	\$30.13	\$27.86	\$25.92	41		
Cable Connectors		Solder/Solder	Female Right Angle						
			RG405, PE-SR405FL, PE-SR405FLJ	PE44913	\$55.04	\$51.19	\$47.33	\$44.03	42
			RG405, PE-SR405FL, PE-SR405FLJ	PE44915	\$27.20	\$25.30	\$23.39	\$21.76	43
			RG405, PE-SR405AL, PE-SR405FL, PE-SR405FLJ	PE45248	\$8.86	\$8.24	\$7.62	\$7.09	44
PE-047SR, PE-SR047AL, PE-SR047FL	PE45249	\$9.22	\$8.57	\$7.93	\$7.38	45			

SSMA Connectors

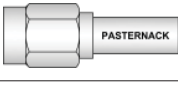
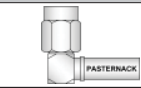
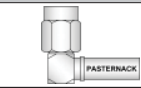
Connection Method	Product Image	Attachment Cable/Contact	Coax Type / Termination Type	Model No.	Price				ROW
					1-24	25-49	50-99	100 +	
Cable Connectors		Crimp/Solder	Male						
			RG174, RG316, RG188, LMR-100, PE-B100, PE-C100, .100 inch	PE44379	\$23.42	\$21.78	\$20.14	\$18.74	46
			RG178, RG196	PE44381	\$27.45	\$25.53	\$23.61	\$21.96	47
			RG188-DS, RG316-DS	PE44416	\$21.77	\$20.25	\$18.72	\$17.42	48
			RG174, RG316, RG188	PE4184	\$23.41	\$21.77	\$20.13	\$18.73	49
Cable Connectors		Solder/Solder	Male Right Angle						
			PE-SR405AL, PE-SR405FL, PE-SR405FLJ, RG405	PE44383	\$31.98	\$29.74	\$27.50	\$25.58	50
Cable Connectors		Crimp/Solder	Male Right Angle						
			RG174, RG316, RG188, PE-B100, PE-C100, .100 inch, LMR-100	PE44378	\$27.62	\$25.69	\$23.75	\$22.10	51
			RG178, RG196	PE44380	\$54.68	\$50.85	\$47.02	\$43.74	52

* Fits MIL-C-17 and equivalent cable versions only



Free Shipping Available via UPS Ground to USA & Canada



Technical Support (866) 727-8376



Same-Day Shipping, Even Custom Cable Assemblies







Connectors

See Our Website For Current Pricing & Real-Time Stock Availability!

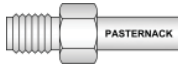
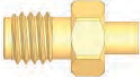
SSMA Connectors

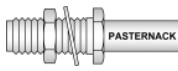
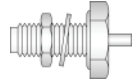
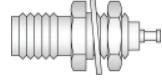
Connection Method	Product Image	Attachment Cable/Contact	Coax Type / Termination Type	Model No.	Price				ROW
					1-24	25-49	50-99	100 +	
Cable Connectors	Male Right Angle								
		Solder/Solder	PE-SR405AL, PE-SR405FL, PE-SR405FLJ, RG405	PE44384	\$37.85	\$35.20	\$32.55	\$30.28	53

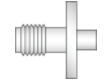
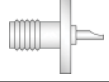
SSMA Connectors







Connection Method	Product Image	Attachment Cable/Contact	Coax Type / Termination Type	Model No.	Price				ROW
					1-24	25-49	50-99	100 +	
Cable Connectors	Female								
		Crimp/Solder	RG174, RG316, RG188, PE-B100, PE-C100, .100 inch, LMR-100	PE44385	\$28.41	\$26.42	\$24.43	\$22.73	54
Cable Connectors		Solder/Solder	PE-SR405AL, PE-SR405FL, PE-SR405FLJ, RG405	PE44387	\$27.21	\$25.31	\$23.40	\$21.77	55
	PCB Mount		Solder	Thru Hole with .200 inch x .067 inch Hole Spacing	PE44391	\$30.87	\$28.71	\$26.55	\$24.70
Cable Connectors	Female, Bulkhead Mount								
		Crimp/Solder	.100 inch, RG316, RG174, RG188, LMR-100, LMR-100A, LMR-100A-FR, PE-C100, PE-B100 with .177 inch D Hole	PE44388	\$38.95	\$36.22	\$33.50	\$31.16	57
			RG178, RG196 with .177 inch D Hole	PE44389	\$33.23	\$30.90	\$28.58	\$26.58	58
			RG188-DS, RG316-DS with .177 inch D Hole	PE44426	\$27.06	\$25.17	\$23.27	\$21.65	59
	Solder/Solder	PE-047SR, PE-SR047AL, PE-SR047FL with .177 inch D Hole	PE44429	\$43.85	\$40.78	\$37.71	\$35.08	60	
Terminal		Solder	Turret with .177 inch D Hole	PE44392	\$33.67	\$31.31	\$28.96	\$26.94	61
			Solder Cup with .177 inch D Hole	PE44393	\$30.31	\$28.19	\$26.07	\$24.25	62
PCB Mount		Solder	.042 inch End Launch	PE45405	\$26.21	\$24.38	\$22.54	\$20.97	63
			.062 inch End Launch	PE45406	\$26.21	\$24.38	\$22.54	\$20.97	64
Cable Connectors	Female, 2 Hole Flange Mount								
		Solder/Solder	PE-047SR, PE-SR047AL, PE-SR047FL with .328 inch Hole Spacing	PE44436	\$39.75	\$36.97	\$34.19	\$31.80	65
Terminal		Solder	Pin with .328 inch Hole Spacing	PE44433	\$44.23	\$41.13	\$38.04	\$35.38	66
Terminal	Female, 4 Hole Flange Mount								
		Solder	Pin with .232 inch Hole Spacing	PE44434	\$39.44	\$36.68	\$33.92	\$31.55	67
PCB Mount		Solder	Thru Hole with .200 inch x .067 inch Hole Spacing	PE44435	\$44.53	\$41.41	\$38.30	\$35.62	68

* Fits MIL-C-17 and equivalent cable versions only

Connectors







See Our Website For Current Pricing & Real-Time Stock Availability!

SSMB Connectors

Connection Method	Product Image	Attachment Cable/Contact	Coax Type / Termination Type	Model No.	Price				ROW
					1-24	25-49	50-99	100 +	
Plug									
Cable Connectors		Crimp/Solder	RG174, RG316, RG188, LMR-100, PE-B100, PE-C100, .100 inch	PE4017	\$28.69	\$26.68	\$24.67	\$22.95	69
			RG178, RG196	PE45195	\$16.12	\$14.99	\$13.86	\$12.90	71
Plug Right Angle									
Cable Connectors		Crimp/Solder	RG174, RG179, RG316, RG188, PE-B100, PE-C100, .100 inch, LMR-100	PE4334	\$49.60	\$46.13	\$42.66	\$39.68	70
			RG178, RG196	PE45195	\$16.12	\$14.99	\$13.86	\$12.90	71
Jack									
PCB Mount		Solder	Thru Hole with .100 inch x .031 inch Hole Spacing	PE4340	\$12.72	\$11.83	\$10.94	\$10.18	72
Jack, Bulkhead Mount									
Cable Connectors		Crimp/Solder	.100 inch, RG316, RG174, RG188, LMR-100, LMR-100A, LMR-100A-FR, PE-C100, PE-B100 with .126 inch D Hole	PE4336	\$33.80	\$31.43	\$29.07	\$27.04	73
			RG178, RG196 with .126 inch D Hole	PE4337	\$30.17	\$28.06	\$25.95	\$24.14	74
Jack, 4 Hole Flange Mount									
Terminal		Solder	Tab with .164 inch x .067 inch Hole Spacing	PE44455	\$22.74	\$21.15	\$19.56	\$18.19	75
Jack Right Angle									
PCB Mount		Solder	Thru Hole with .100 inch x .031 inch Hole Spacing	PE4341	\$20.79	\$19.33	\$17.88	\$16.63	76

Connectors

SSMC Connectors

Connection Method	Product Image	Attachment Cable/Contact	Coax Type / Termination Type	Model No.	Price				ROW
					1-24	25-49	50-99	100 +	
Plug									
Cable Connectors		Crimp/Solder	RG316, RG174, RG188	PE45209	\$14.69	\$13.66	\$12.63	\$11.75	77
			RG178, RG196	PE45367	\$26.37	\$24.52	\$22.68	\$21.10	78
			LMR-100A, RG188, RG174, PE-C100-LSZH, PE-B100, LMR-100A-FR, RG316	PE45368	\$24.15	\$22.46	\$20.77	\$19.32	79
			RG188-DS, RG316-DS	PE45369	\$25.77	\$23.97	\$22.16	\$20.62	80
			PE-SR405AL, PE-SR405FL, PE-SR405FLJ, PE-SR405TN, RG405	PE45365	\$23.48	\$21.84	\$20.19	\$18.78	81
		Clamp/Solder	PE-047SR, PE-SR047AL, PE-SR047FL	PE45366	\$23.73	\$22.07	\$20.41	\$18.98	82
Plug Right Angle									
Cable Connectors		Crimp/Solder	RG178, RG196	PE45381	\$18.27	\$16.99	\$15.71	\$14.62	83
			RG316, RG188, RG174, PE-C100-LSZH, PE-B100, LMR-100A-FR, LMR-100A	PE45382	\$20.84	\$19.38	\$17.92	\$16.67	84
			RG316-DS, RG188-DS	PE45383	\$20.53	\$19.09	\$17.66	\$16.42	85
			PE-SR405AL, PE-SR405FL, PE-SR405FLJ, PE-SR405TN, RG405	PE45384	\$20.50	\$19.07	\$17.63	\$16.40	86
		Solder/Solder	PE-047SR, PE-SR047AL, PE-SR047FL	PE45385	\$23.59	\$21.94	\$20.29	\$18.87	87
PCB Mount		Solder	Thru Hole	PE45379	\$28.21	\$26.24	\$24.26	\$22.57	88
Jack									
Cable Connectors		Crimp/Solder	RG316, RG188	PE45373	\$22.27	\$20.71	\$19.15	\$17.82	89
			RG316-DS, RG188-DS	PE45374	\$23.84	\$22.17	\$20.50	\$19.07	90
		Clamp/Solder	PE-047SR, PE-SR047AL, PE-SR047FL	PE45371	\$23.45	\$21.81	\$20.17	\$18.76	91

See Our Website For Current Pricing & Real-Time Stock Availability!

* Fits MIL-C-17 and equivalent cable versions only



Free Shipping Available via UPS Ground to USA & Canada













Technical Support (866) 727-8376



Same-Day Shipping, Even Custom Cable Assemblies

SSMC Connectors

Connection Method	Product Image	Attachment Cable/Contact	Coax Type / Termination Type	Model No.	Price				ROW
					1-24	25-49	50-99	100 +	
PCB Mount		Solder	Surface Mount	PE45376	\$16.36	\$15.21	\$14.07	\$13.09	92
Jack, Bulkhead Mount									
Cable Connectors		Crimp/Solder	RG-178, RG-196	PE45372	\$22.54	\$20.96	\$19.38	\$18.03	93
		Clamp/Solder	PE-SR405AL, PE-SR405FL, PE-SR405FLJ, PE-SR405TN, RG405	PE45370	\$16.92	\$15.74	\$14.55	\$13.54	94
Terminal		Solder	Turret	PE45375	\$17.72	\$16.48	\$15.24	\$14.18	95
			Turret	PE45390	\$16.36	\$15.21	\$14.07	\$13.09	96
Jack, 2 Hole Flange Mount									
Terminal		Solder	Solder Cup	PE45380	\$109.65	\$101.97	\$94.30	\$87.72	97
Jack, 4 Hole Flange Mount									
Terminal		Solder	Solder Cup	PE45391	\$60.47	\$56.24	\$52.00	\$48.38	98
Jack Right Angle									
Cable Connectors		Crimp/Solder	PE-SR405AL, PE-SR405FL, PE-SR405FLJ, PE-SR405TN, RG405	PE45387	\$32.86	\$30.56	\$28.26	\$26.29	99
		Solder/Solder	PE-047SR, PE-SR047AL, PE-SR047FL	PE45388	\$36.55	\$33.99	\$31.43	\$29.24	1
PCB Mount		Solder	Surface Mount	PE45377	\$26.65	\$24.78	\$22.92	\$21.32	2
			Turret	PE45389	\$33.01	\$30.70	\$28.39	\$26.41	3
Jack Right Angle, Bulkhead Mount									
Cable Connectors		Crimp/Solder	RG178, RG196	PE45386	\$20.19	\$18.78	\$17.36	\$16.15	4
Terminal		Solder	Turret	PE45378	\$38.80	\$36.08	\$33.37	\$31.04	5

TNC Connectors

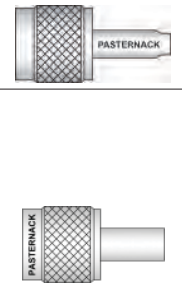
Connection Method	Product Image	Attachment Cable/Contact	Coax Type / Termination Type	Model No.	Price				ROW
					1-24	25-49	50-99	100 +	
Male									
Cable Connectors		Crimp/Crimp	RG55, RG142, RG223, RG400, RG141	PE4047	\$12.75	\$11.86	\$10.97	\$10.20	6
			RG174, RG316, RG188, LMR-100, PE-B100, PE-C100, .100 inch	PE4302	\$19.74	\$18.36	\$16.98	\$15.79	7
			PE-C200, LMR-200	PE44804	\$8.43	\$7.84	\$7.25	\$6.74	8
			RG59*, RG62*, RG71	PE4071	\$11.52	\$10.71	\$9.91	\$9.22	9
			RG58, RG303, RG141, PE-C195, PE-P195, LMR-195, .195 inch	PE4156	\$7.28	\$6.77	\$6.26	\$5.82	10
			PE-C400, PE-B400, PE-B405, LMR-400, LMR-400-DB, LMR-400-UF, .400 inch	PE44293	\$30.06	\$27.96	\$25.85	\$24.05	11
			RG213, RG8	PE4446	\$17.42	\$16.20	\$14.98	\$13.94	12
			RG214, RG9, RG225, RG393	PE4447	\$26.50	\$24.65	\$22.79	\$21.20	13
			PE-C240, RG8X, .240 inch, LMR-240, LMR-240-DB, LMR-240-UF, B7808A	PE44634	\$12.33	\$11.47	\$10.60	\$9.86	14
			LMR-100, PE-C100, RG174, RG188, RG316	TC-100-TM	\$18.78	\$18.78	\$18.78	\$18.78	15
			LMR-240, PE-C240	TC-240-TM-X	\$8.67	\$8.67	\$8.67	\$8.67	16
			LMR-400, PE-C400	TC-400-TM-X	\$11.30	\$11.30	\$11.30	\$11.30	17

* Fits MIL-C-17 and equivalent cable versions only

Connectors

See Our Website For Current Pricing & Real-Time Stock Availability!

TNC Connectors

Connection Method	Product Image	Attachment Cable/Contact	Coax Type / Termination Type	Model No.	Price				ROW
					1-24	25-49	50-99	100 +	
Male									
Cable Connectors		Clamp/Solder	RG58, RG55, RG141, RG142, RG223, RG400, RG303, PE-C195, PE-P195, LMR-195	PE4067	\$23.96	\$22.28	\$20.61	\$19.17	18
			RG213, RG214, RG8, RG9, RG11*, RG225, RG393, RG144*, RG215, RG216*	PE4088	\$18.18	\$16.91	\$15.63	\$14.54	19
			RG59*, RG62*, RG71	PE4154	\$14.83	\$13.79	\$12.75	\$11.86	20
			RG174, RG316, RG188	PE4303	\$14.21	\$13.22	\$12.22	\$11.37	21
			PE-C400, PE-B400, PE-B405, LMR-400, LMR-400-DB, LMR-400-UF, .400 inch	PE4449	\$19.58	\$18.21	\$16.84	\$15.66	22
			PE-P300LL	PE44810	\$90.60	\$84.26	\$77.92	\$72.48	23
			PE-P142LL	PE44815	\$52.37	\$48.70	\$45.04	\$41.90	24
			RG8X, PE-C240, .240 inch, B7808A, LMR-240	PE45437	\$16.30	\$15.16	\$14.02	\$13.04	25
	PE-P160LL	PE45443	\$77.42	\$72.00	\$66.58	\$61.94	26		
		Solder/Solder	PE-SR405AL, PE-SR405FL, PE-SR405FLJ, PE-SR405TN, RG405	PE44708	\$13.35	\$12.42	\$11.48	\$10.68	27
			PE-SR405AL, PE-SR405FL, RG405	PE4649	\$26.85	\$24.97	\$23.09	\$21.48	28
		Crimp/Non-Solder Contact	LMR-200, PE-C200	EZ-200-TM-X	\$18.76	\$18.76	\$18.76	\$18.76	29
LMR-240, PE-C240			EZ-240-TM-X	\$12.73	\$12.73	\$12.73	\$12.73	30	
LMR-400, PE-C400, PE-B400, PE-B405			EZ-400-TM-X	\$13.96	\$13.96	\$13.96	\$13.96	31	
LMR-600, PE-C600			EZ-600-TM-X	\$22.47	\$22.47	\$22.47	\$22.47	32	
Male, 4 Hole Flange Mount									
Terminal		Solder	Solder Cup with .531 inch Hole Spacing	PE4470	\$19.61	\$18.24	\$16.86	\$15.69	33
Male Right Angle									
Cable Connectors		Crimp/Crimp	RG58, RG303, RG141, PE-C195, PE-P195, LMR-195, .195 inch	PE4451	\$23.84	\$22.17	\$20.50	\$19.07	34
			RG55, RG141, RG142, RG223, RG400	PE4450	\$17.07	\$15.88	\$14.68	\$13.66	35
		Crimp/Solder	RG59*, RG62*, RG71	PE4453	\$23.90	\$22.23	\$20.55	\$19.12	36
			RG174, RG316, RG188, .100 inch, PE-B100, PE-C100, LMR-100	PE4455	\$24.73	\$23.00	\$21.27	\$19.78	37
			PE-C240, RG8X, .240 inch, LMR-240, LMR-240-DB, LMR-240-UF, B7808A	PE44635	\$24.99	\$23.24	\$21.49	\$19.99	38
			PE-C200, LMR-200	PE44846	\$19.14	\$17.80	\$16.46	\$15.31	39
		Solder/Solder	LMR-400, PE-C400	TC-400-TM-RA-D	\$24.98	\$24.98	\$24.98	\$24.98	40
			RG58, RG55, RG141, RG142, RG223, RG400, RG303, PE-C195, PE-P195, LMR-195	PE4054	\$25.29	\$23.52	\$21.75	\$20.23	41
	Clamp/Solder	RG213, RG214, RG8, RG9, RG11*, RG225, RG393, RG144*, RG216*, RG215	PE4146	\$32.64	\$30.36	\$28.07	\$26.11	42	
		RG59*, RG62*	PE4452	\$40.06	\$37.26	\$34.45	\$32.05	43	
		PE-P160LL	PE45445	\$133.97	\$124.59	\$115.21	\$107.18	44	
	Solder/Solder	PE-SR402AL, PE-SR402FL, PE-SR402FLJ, PE-SR402TN, RG402	PE44711	\$14.57	\$13.55	\$12.53	\$11.66	45	
		Female							
Cable Connectors		Crimp/Solder	RG55, RG141, RG142, RG223, RG400	PE4457	\$13.78	\$12.82	\$11.85	\$11.02	46
			RG58, RG303, RG141, PE-C195, PE-P195, LMR-195, .195 inch	PE4458	\$14.66	\$13.63	\$12.61	\$11.73	47
			RG174, RG316, RG188, PE-B100, PE-C100, .100 inch, LMR-100	PE4462	\$18.79	\$17.47	\$16.16	\$15.03	48
			PE-C240, RG8X, .240 inch, LMR-240, LMR-240-DB, LMR-240-UF, B7808A	PE44636	\$17.27	\$16.06	\$14.85	\$13.82	49
	RG316, RG174, LMR-100	PE45143	\$9.55	\$8.88	\$8.21	\$7.64	50		
		Clamp/Solder	RG58, RG55, RG141, RG142, RG223, RG400, RG303, PE-C195, PE-P195, LMR-195	PE4068	\$12.80	\$11.90	\$11.01	\$10.24	51
RG213, RG214, RG8, RG9, RG11*, RG225, RG393, RG144*, RG216*, RG215			PE4155	\$33.84	\$31.47	\$29.10	\$27.07	52	

Connectors

See Our Website For Current Pricing & Real-Time Stock Availability!

* Fits MIL-C-17 and equivalent cable versions only



Free Shipping Available via UPS Ground to USA & Canada







Technical Support (866) 727-8376



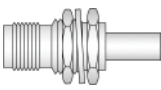
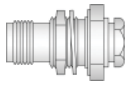
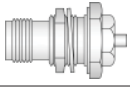

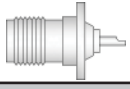
Same-Day Shipping, Even Custom Cable Assemblies

TNC Connectors

Connection Method	Product Image	Attachment Cable/Contact	Coax Type / Termination Type	Model No.	Price				ROW
					1-24	25-49	50-99	100 +	
Female, Bulkhead Mount									
Cable Connectors		Crimp/Solder	RG58, RG303, RG141, PE-C195, PE-P195, LMR-195, .195 inch with .480 inch D Hole	PE4151	\$18.88	\$17.56	\$16.24	\$15.10	53
			RG55, RG141, RG142, RG223, RG400 with .480 inch D Hole	PE4153	\$17.90	\$16.65	\$15.39	\$14.32	54
			RG174, RG316, RG188, LMR-100, PE-B100, PE-C100, .100 inch with .480 inch D Hole	PE4466	\$24.01	\$22.33	\$20.65	\$19.21	55
			RG174, RG316, RG188, .100 inch, PE-B100, PE-C100, LMR-100	PE44900	\$58.48	\$54.39	\$50.29	\$46.78	56
		Clamp/Solder	PE-SR402AL, PE-SR402FL, RG402 with .480 inch D Hole	PE4150	\$24.31	\$22.61	\$20.91	\$19.45	57
			RG58, RG142, RG223, RG400, RG141, RG303, RG55, LMR-400, PE-C195, PE-P195 with .480 inch D Hole	PE4152	\$19.25	\$17.90	\$16.56	\$15.40	58
			RG174, RG316, RG188 with .480 inch D Hole	PE4304	\$19.96	\$18.56	\$17.17	\$15.97	59
			RG59*, RG62*, RG71 with .480 inch D Hole	PE4464	\$29.29	\$27.24	\$25.19	\$23.43	60
			PE-P142LL	PE44811	\$84.46	\$78.55	\$72.64	\$67.57	61
			PE-P160LL	PE45444	\$102.71	\$95.52	\$88.33	\$82.17	62
		Solder/Solder	PE-SR402AL, PE-SR402FL, RG402 with .480 inch D Hole	PE4148	\$64.29	\$59.79	\$55.29	\$51.43	63
			PE-SR405AL, PE-SR405FL, PE-SR405FLJ, PE-SR405TN, RG405	PE44714	\$16.03	\$14.91	\$13.79	\$12.82	64
Solder Cup with .350 inch D Hole			PE4065	\$13.00	\$12.09	\$11.18	\$10.40	65	
Eyelet with .350 inch D Hole			PE4305	\$30.35	\$28.23	\$26.10	\$24.28	66	
Terminal		Solder	Solder Cup with .350 inch D Hole	PE4306	\$11.47	\$10.67	\$9.86	\$9.18	67
			Eyelet with .480 inch D Hole	PE4469	\$39.81	\$37.02	\$34.24	\$31.85	68
			Female, 4 Hole Flange Mount						
Terminal		Solder	Solder Cup with .500 inch Threaded Hole Spacing	PE4064	\$13.03	\$12.12	\$11.21	\$10.42	69
			Solder Cup with .500 inch Threaded Hole Spacing	PE4064SP	\$19.41	\$18.05	\$16.69	\$15.53	70
Female Right Angle, Bulkhead Mount									
Terminal		Solder	Solder Cup with .361 inch D Hole	PE4471	\$28.69	\$26.68	\$24.67	\$22.95	71

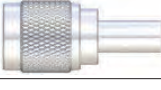
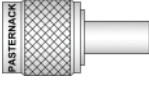
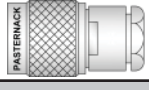
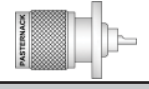
Reverse Polarity TNC Connectors



Connection Method	Product Image	Attachment Cable/Contact	Coax Type / Termination Type	Model No.	Price				ROW
					1-24	25-49	50-99	100 +	
Male									
Cable Connectors		Crimp/Crimp	LMR-200, PE-C200	PE45283	\$17.57	\$16.34	\$15.11	\$14.06	72
			PE-C240, RG8X, .240 inch, LMR-240, LMR-240-DB, LMR-240-UF, B7808A	PE44670	\$10.47	\$9.74	\$9.00	\$8.38	73
		Crimp/Solder	PE-C400, PE-B400, PE-B405, LMR-400, LMR-400-DB, LMR-400-UF, .400 inch	PE44672	\$17.86	\$16.61	\$15.36	\$14.29	74
			RG214, RG9, RG225, RG393	PE4661	\$23.54	\$21.89	\$20.24	\$18.83	75
			RG55, RG141, RG142, RG223, RG400	PE4663	\$13.73	\$12.77	\$11.81	\$10.98	76
			RG58	PE4664	\$11.65	\$10.83	\$10.02	\$9.32	77
		Clamp/Solder	RG174, RG316, RG188, LMR-100, PE-B100, PE-C100, .100 inch	PE4668	\$22.32	\$20.76	\$19.20	\$17.86	78
RG58, RG55, RG141, RG142, RG223, RG400, RG303, PE-C195, PE-P195, LMR-195			PE4662	\$12.70	\$11.81	\$10.92	\$10.16	79	
Male, 4 Hole Flange Mount									
Terminal		Solder	Solder Cup with .531 inch Hole Spacing	PE4708	\$22.32	\$20.76	\$19.20	\$17.86	80
Male Right Angle									
Cable Connectors		Crimp/Solder	RG55, RG141, RG142, RG223, RG400	PE4677	\$23.17	\$21.55	\$19.93	\$18.54	81
			RG58, RG303, RG141, PE-C195, PE-P195, LMR-195, .195 inch	PE4678	\$25.29	\$23.52	\$21.75	\$20.23	82
			RG316, RG174, RG188, LMR-100, PE-B100, PE-C100, .100 inch	PE4681	\$26.81	\$24.93	\$23.06	\$21.45	83

* Fits MIL-C-17 and equivalent cable versions only

Connectors

See Our Website For Current Pricing & Real-Time Stock Availability!

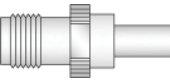
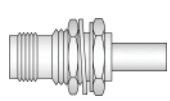
Reverse Polarity TNC Connectors





Connection Method	Product Image	Attachment Cable/Contact	Coax Type / Termination Type	Model No.	Price				ROW
					1-24	25-49	50-99	100 +	
Male Right Angle									
Cable Connectors		Clamp/Solder	RG213, RG214, RG8, RG9, RG225, RG393, RG215	PE4675	\$44.06	\$40.98	\$37.89	\$35.25	84
Female									
Cable Connectors		Crimp/Solder	PE-C400, PE-B400, PE-B405, LMR-400, LMR-400-DB, LMR-400-UF, .400 inch	PE44673	\$12.53	\$11.65	\$10.78	\$10.02	85
			RG58, RG303, RG141, PE-C195, PE-P195, LMR-195, .195 inch	PE4686	\$16.01	\$14.89	\$13.77	\$12.81	86
Female, Bulkhead Mount									
Cable Connectors		Crimp/Solder	RG174, RG316, RG188, .100 inch, PE-B100, PE-C100, LMR-100	PE44902	\$48.73	\$45.32	\$41.91	\$38.98	87
			RG55, RG141, RG142, RG223, RG400 with .480 inch D Hole	PE4695	\$18.93	\$17.60	\$16.28	\$15.14	88
			.195 inch, RG58, RG141, RG303, LMR-195, LMR-195-FR, PE-C195, PE-P195 with .480 inch D Hole	PE4696	\$26.20	\$24.37	\$22.53	\$20.96	89
	.100 inch, RG316, RG174, RG188, LMR-100, LMR-100A, LMR-100A-FR, PE-C100, PE-B100 with .480 inch D Hole	PE4700	\$25.77	\$23.97	\$22.16	\$20.62	90		
	Clamp/Solder	RG58, RG142, RG223, RG400, RG141, RG303, RG55, PE-C195, PE-P195 with .480 inch D Hole	PE4694	\$21.47	\$19.97	\$18.46	\$17.18	91	
		RG316, RG174, RG188 with .480 inch D Hole	PE4699	\$22.81	\$21.21	\$19.62	\$18.25	92	

TNC Torque Wrenches



Type	Bit Hex Size (in.)	Preset Torque (in.-lbs.)	Model No.	1-24	25-49	50-99	100+	ROW
TNC	5/8 inch	14 in-lbs	PE5011-4	\$302.48	\$281.31	\$260.13	\$241.98	
	9/16 inch	13 in-lbs	PE5011-8	\$285.35	\$265.38	\$245.40	\$228.28	
	5/8 inch	12 in-lbs	PE5019-10	\$213.81	\$198.84	\$183.88	\$171.05	

UHF Connectors

Connection Method	Product Image	Attachment Cable/Contact	Coax Type / Termination Type	Model No.	Price				ROW
					1-24	25-49	50-99	100 +	
Male									
Cable Connectors		Crimp/Solder	RG58, RG303, RG141, PE-C195, PE-P195, LMR-195, .195 inch	PE4069	\$9.15	\$8.51	\$7.87	\$7.32	93
			RG213, RG215, RG8	PE4295	\$14.99	\$13.94	\$12.89	\$11.99	94
			RG55, RG141, RG142, RG223, RG400	PE44053	\$8.26	\$7.68	\$7.10	\$6.61	95
		Clamp/Solder	RG213, RG214, RG8, RG9, RG11*, RG225, RG393, RG144*, RG215, RG216*	PE44050	\$11.40	\$10.60	\$9.80	\$9.12	96
			RG58, RG55, RG141, RG142, RG223, RG400, RG303, PE-C195, PE-P195, LMR-195	PE44052	\$11.33	\$10.54	\$9.74	\$9.06	97
	Solder	RG213, RG55, RG141, RG142, RG223, RG400, RG303, PE-C195, PE-P195, LMR-195	PE4020	\$14.10	\$13.11	\$12.13	\$11.28	98	
	Crimp/Non-Solder Contact	LMR-400, PE-C400, PE-B400, PE-B405	EZ-400-UM	\$19.66	\$19.66	\$19.66	\$19.66	99	
Female									
Cable Connectors		Clamp/Solder	RG213, RG214, RG8, RG9, RG11*, RG225, RG393, RG144*, RG216*, RG215	PE44055	\$14.70	\$13.67	\$12.64	\$11.76	1

* Fits MIL-C-17 and equivalent cable versions only



Free Shipping Available via UPS Ground to USA & Canada



Technical Support (866) 727-8376





Same-Day Shipping, Even Custom Cable Assemblies

Connectors

See Our Website For Current Pricing & Real-Time Stock Availability!



UHF Connectors

Connection Method	Product Image	Attachment Cable/Contact	Coax Type / Termination Type	Model No.	Price				ROW
					1-24	25-49	50-99	100 +	
Female, Bulkhead Mount									
Terminal		Solder	Solder Cup with .575 inch D Hole	PE44059	\$10.94	\$10.17	\$9.41	\$8.75	2
Female, 4 Hole Flange Mount									
Terminal		Solder	Solder Cup with .718 inch Hole Spacing	PE4012	\$8.76	\$8.15	\$7.53	\$7.01	3

UMCX Connectors

Connection Method	Product Image	Attachment Cable/Contact	Coax Type / Termination Type	Model No.	Price				ROW
					1-24	25-49	50-99	100 +	
Jack									
PCB Mount		Solder	Surface Mount	PE44594	\$1.54	\$1.43	\$1.32	\$1.23	4

75 Ohm 1.0/2.3 Connectors

Connection Method	Product Image	Attachment Cable/Contact	Coax Type / Termination Type	Model No.	Price				ROW
					1-24	25-49	50-99	100 +	
Plug									
Cable Connectors		Crimp/Crimp	BELDEN 735A1	PE45227	\$11.15	\$10.37	\$9.59	\$8.92	5
			BELDEN 1855A	PE45228	\$11.15	\$10.37	\$9.59	\$8.92	6
			RG179-DS	PE45233	\$11.15	\$10.37	\$9.59	\$8.92	7
			RG59*	PE45234	\$11.15	\$10.37	\$9.59	\$8.92	8
			RG6-CATV	PE45235	\$16.74	\$15.57	\$14.40	\$13.39	9
Jack, Bulkhead Mount									
PCB Mount		Solder	Thru Hole	PE45229	\$14.66	\$13.63	\$12.61	\$11.73	10
			Thru Hole	PE45231	\$17.02	\$15.83	\$14.64	\$13.62	11
			End Launch	PE45232	\$18.97	\$17.64	\$16.31	\$15.18	12
Jack Right Angle, Bulkhead Mount									
PCB Mount		Solder	Thru Hole	PE45230	\$14.66	\$13.63	\$12.61	\$11.73	13
			Thru Hole	PE45237	\$17.33	\$16.12	\$14.90	\$13.86	14

75 Ohm BNC Connectors

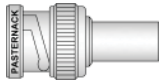
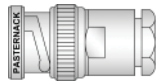



Connection Method	Product Image	Attachment Cable/Contact	Coax Type / Termination Type	Model No.	Price				ROW
					1-24	25-49	50-99	100 +	
Male									
Cable Connectors		Crimp/Crimp	RG59*, RG62*, RG71	PE4602	\$10.42	\$9.69	\$8.96	\$8.34	15
			1505A	PE44626	\$9.66	\$8.98	\$8.31	\$7.73	16
			RG6	PE4598	\$6.55	\$6.09	\$5.63	\$5.24	17
			RG11*, RG216*, RG144*	PE4600	\$19.61	\$18.24	\$16.86	\$15.69	18
		Clamp/Solder	RG179, RG187	PE4604	\$12.20	\$11.35	\$10.49	\$9.76	19
			RG11*, RG144*, RG216*	PE4599	\$31.01	\$28.84	\$26.67	\$24.81	20
			RG59*, RG62*, RG71	PE4601	\$15.35	\$14.28	\$13.20	\$12.28	21
			RG179, RG187	PE4603	\$14.29	\$13.29	\$12.29	\$11.43	22

* Fits MIL-C-17 and equivalent cable versions only

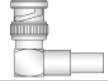
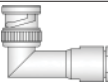

Connectors

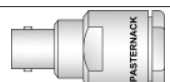
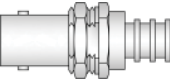
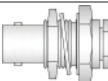
See Our Website For Current Pricing & Real-Time Stock Availability!

75 Ohm BNC Connectors

Connection Method	Product Image	Attachment Cable/Contact	Coax Type / Termination Type	Model No.	Price				ROW
					1-24	25-49	50-99	100 +	
Male Right Angle									
Cable Connectors		Crimp/Solder	RG59*, RG62*, RG71	PE4608	\$29.14	\$27.10	\$25.06	\$23.31	23
			RG179, RG187	PE4610	\$23.04	\$21.43	\$19.81	\$18.43	24
		Clamp/Solder	RG6	PE4605	\$29.11	\$27.07	\$25.03	\$23.29	25
Female									
Cable Connectors		Crimp/Solder	735A	PE44688	\$26.44	\$24.59	\$22.74	\$21.15	26
			RG179, RG187	PE4616	\$17.33	\$16.12	\$14.90	\$13.86	27
		Clamp/Solder	RG6	PE4611	\$41.22	\$38.33	\$35.45	\$32.98	28
			RG59*	PE4613	\$18.79	\$17.47	\$16.16	\$15.03	29
			RG179, RG187	PE4615	\$27.08	\$25.18	\$23.29	\$21.66	30
Female, Bulkhead Mount									
Cable Connectors		Crimp/Solder	RG59*, RG62*, RG71 with .480 inch D Hole	PE4638	\$27.28	\$25.37	\$23.46	\$21.82	31
			RG179, RG187 with .480 inch D Hole	PE4640	\$21.26	\$19.77	\$18.28	\$17.01	32
		Clamp/Solder	RG179, RG187 with .480 inch D Hole	PE4639	\$27.06	\$25.17	\$23.27	\$21.65	33
Terminal		Solder	Solder Cup with .350 inch D Hole	PE4620	\$12.94	\$12.03	\$11.13	\$10.35	34
			Turret with .480 inch D Hole	PE4621	\$36.94	\$34.35	\$31.77	\$29.55	35
			Turret with .350 inch D Hole	PE4624	\$32.32	\$30.06	\$27.80	\$25.86	36
			Solder Cup with .350 inch D Hole	PE4626	\$11.23	\$10.44	\$9.66	\$8.98	37
Female, 4 Hole Flange Mount									
Terminal		Solder	Turret with .531 inch Hole Spacing	PE4618	\$42.45	\$39.48	\$36.51	\$33.96	38

75 Ohm F Connectors

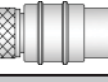
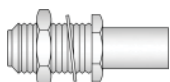
Connection Method	Product Image	Attachment Cable/Contact	Coax Type / Termination Type	Model No.	Price				ROW
					1-24	25-49	50-99	100 +	
Male									
Cable Connectors		Crimp/Crimp	RG59*, RG62*, RG71	PE44317	\$4.53	\$4.21	\$3.90	\$3.62	39
			Crimp/Solder	RG6-CATV	PE44313	\$4.71	\$4.38	\$4.05	\$3.77
	RG179, RG187	PE44319		\$5.85	\$5.44	\$5.03	\$4.68	41	
		Crimp/Non-Solder Contact	LMR-400-75	PE44582	\$4.69	\$4.36	\$4.03	\$3.75	42
Cable Connectors		Crimp/Solder	RG6-CATV	EZ-400-FM-75	\$27.86	\$27.86	\$27.86	\$27.86	43
			RG59*, RG62*, RG71	PE44320	\$6.91	\$6.43	\$5.94	\$5.53	44
			RG179, RG187 with .380 inch DD Hole	PE44322	\$6.52	\$6.06	\$5.61	\$5.22	45
Female, Bulkhead Mount									
Cable Connectors		Crimp/Solder	RG6-CATV	PE44324	\$7.88	\$7.33	\$6.78	\$6.30	46
			RG59*, RG62*, RG71	PE44325	\$4.80	\$4.46	\$4.13	\$3.84	47
			RG179, RG187 with .380 inch DD Hole	PE44326	\$6.25	\$5.81	\$5.38	\$5.00	48

* Fits MIL-C-17 and equivalent cable versions only



Free Shipping Available
via UPS Ground to
USA & Canada



Technical Support
(866) 727-8376





Same-Day Shipping,
Even Custom
Cable Assemblies



Connectors

See Our Website For Current Pricing & Real-Time Stock Availability!







75 Ohm MCX Connectors

Connection Method	Product Image	Attachment Cable/Contact	Coax Type / Termination Type	Model No.	Price				ROW
					1-24	25-49	50-99	100 +	
Plug									
Cable Connectors		Crimp/Solder	RG179, RG187	PE44298	\$12.98	\$12.07	\$11.16	\$10.38	49
			RG179, RG187	PE45086	\$15.57	\$14.48	\$13.39	\$12.46	50
Plug Right Angle									
Cable Connectors		Crimp/Solder	RG179, RG187	PE45086	\$15.57	\$14.48	\$13.39	\$12.46	50

75 Ohm Mini SMB Connectors

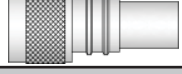
Connection Method	Product Image	Attachment Cable/Contact	Coax Type / Termination Type	Model No.	Price				ROW
					1-24	25-49	50-99	100 +	
Plug									
Cable Connectors		Crimp/Solder	RG179, RG187	PE4993	\$16.47	\$15.32	\$14.16	\$13.18	51
			RG59*, RG62*, RG71	PE4994	\$24.00	\$22.32	\$20.64	\$19.20	52
Plug Right Angle									
Cable Connectors		Crimp/Solder	PE-B159, 1855A, Mini 59	PE44589	\$31.78	\$29.56	\$27.33	\$25.42	53
Jack									
PCB Mount		Solder	Thru Hole with .200 inch x .055 inch Hole Spacing	PE4997	\$14.70	\$13.67	\$12.64	\$11.76	54

75 Ohm N Connectors



Connection Method	Product Image	Attachment Cable/Contact	Coax Type / Termination Type	Model No.	Price				ROW
					1-24	25-49	50-99	100 +	
Male									
Cable Connectors		Crimp/Solder	RG6	PE4508	\$22.53	\$20.95	\$19.38	\$18.02	55
			RG11*, RG144*, RG216*	PE4510	\$22.53	\$20.95	\$19.38	\$18.02	56
			RG59*, RG62*, RG71	PE4512	\$22.32	\$20.76	\$19.20	\$17.86	57
			RG179, RG187	PE4656	\$32.19	\$29.94	\$27.68	\$25.75	58
		Clamp/Solder	RG6	PE4507	\$20.92	\$19.46	\$17.99	\$16.74	59
			RG11*, RG144*, RG216*	PE4509	\$28.70	\$26.69	\$24.68	\$22.96	60
	Crimp/Non-Solder Contact	LMR-400-75	EZ-400-NM-75	\$36.99	\$36.99	\$36.99	\$36.99	62	
		LMR-400-75	EZ-400-NM-75	\$36.99	\$36.99	\$36.99	\$36.99	62	
Male, 4 Hole Flange Mount									
Terminal		Solder	Solder Cup with .718 inch Hole Spacing	PE4504	\$22.32	\$20.76	\$19.20	\$17.86	63
Male Right Angle									
Cable Connectors		Clamp/Solder	RG11*, RG144*, RG216*	PE4502	\$45.28	\$42.11	\$38.94	\$36.22	64
Female									
Cable Connectors		Clamp/Solder	RG11*, RG144*, RG216* with .480 inch D Hole	PE4515	\$31.26	\$29.07	\$26.88	\$25.01	65
			RG59*, RG62*, RG71 with .480 inch D Hole	PE4516	\$35.43	\$32.95	\$30.47	\$28.34	66

* Fits MIL-C-17 and equivalent cable versions only

Connectors

See Our Website For Current Pricing & Real-Time Stock Availability!



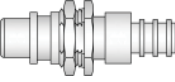

75 Ohm N Connectors

Connection Method	Product Image	Attachment Cable/Contact	Coax Type / Termination Type	Model No.	Price				ROW
					1-24	25-49	50-99	100 +	
Female, Bulkhead Mount									
Terminal		Solder	Solder Cup with .640 inch DD Hole	PE4505	\$25.10	\$23.34	\$21.59	\$20.08	67
			Solder Cup with .380 inch Diameter	PE4506	\$15.86	\$14.75	\$13.64	\$12.69	68
Female, 4 Hole Flange Mount									
Terminal		Solder	Solder Cup with .718 inch Hole Spacing	PE4503	\$16.34	\$15.20	\$14.05	\$13.07	69

75 Ohm RCA Connectors

Connection Method	Product Image	Attachment Cable/Contact	Coax Type / Termination Type	Model No.	Price				ROW
					1-24	25-49	50-99	100 +	
Male									
Cable Connectors		Crimp/Solder	1505A	PE44624	\$14.35	\$13.35	\$12.34	\$11.48	70
Female, Bulkhead Mount									
Cable Connectors		Crimp/Solder	PE-B159, 1855A, Mini 59 with .480 inch D Hole	PE44586	\$15.84	\$14.73	\$13.62	\$12.67	71

75 Ohm SMB Connectors

Connection Method	Product Image	Attachment Cable/Contact	Coax Type / Termination Type	Model No.	Price				ROW
					1-24	25-49	50-99	100 +	
Plug									
Cable Connectors		Crimp/Solder	PE-B150, RG180, RG195	PE4157	\$21.41	\$19.91	\$18.41	\$17.13	72
			RG179, RG187	PE4248	\$17.94	\$16.68	\$15.43	\$14.35	73
Plug, Bulkhead Mount									
Terminal		Solder	Solder Cup with .295 inch D Hole	PE4290	\$55.94	\$52.02	\$48.11	\$44.75	74
Jack									
PCB Mount		Solder	Thru Hole with .200 inch x .067 inch Hole Spacing	PE4110	\$16.46	\$15.31	\$14.16	\$13.17	75
Jack Right Angle									
PCB Mount		Solder	Thru Hole with .200 inch x .067 inch Hole Spacing	PE4179	\$23.01	\$21.40	\$19.79	\$18.41	76

PasterFact™:

The terms "mast" and "tower" are often used interchangeably. However, in structural engineering terms, a tower is a self-supporting or cantilevered structure, while a mast is held up by stays.

* Fits MIL-C-17 and equivalent cable versions only



Free Shipping Available
via UPS Ground
to USA & Canada











Technical
Support
(866) 727-8376

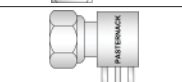
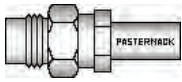

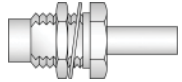

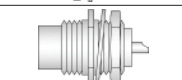
Same-Day Shipping,
Even Custom
Cable Assemblies

75 Ohm SMC Connectors

Connection Method	Product Image	Attachment Cable/Contact	Coax Type / Termination Type	Model No.	Price				ROW
					1-24	25-49	50-99	100 +	
Plug									
Cable Connectors		Crimp/Solder	PE-B150, RG180, RG195	PE4158	\$24.63	\$22.91	\$21.18	\$19.70	77
			RG179, RG187	PE4249	\$20.05	\$18.65	\$17.24	\$16.04	78
		Clamp/Solder	RG59*, RG62*, RG71	PE4258	\$42.39	\$39.42	\$36.46	\$33.91	79
Plug Right Angle									
Cable Connectors		Crimp/Solder	RG180, RG195	PE4162	\$32.59	\$30.31	\$28.03	\$26.07	80
			RG179, RG187	PE4252	\$31.98	\$29.74	\$27.50	\$25.58	81
PCB Mount		Solder	Thru Hole with .200 inch x .067 inch Hole Spacing	PE4293	\$38.88	\$36.16	\$33.44	\$31.10	82
Jack									
Cable Connectors		Crimp/Solder	RG179, RG187	PE4254	\$30.99	\$28.82	\$26.65	\$24.79	83
				Clamp/Solder	RG179, RG187	PE4929	\$28.69	\$26.68	\$24.67
PCB Mount		Solder	Thru Hole with .200 inch x .067 inch Hole Spacing	PE4176	\$16.27	\$15.13	\$13.99	\$13.02	85
Jack, Bulkhead Mount									
Cable Connectors		Crimp/Solder	RG179, RG187 with .285 inch D Hole	PE4256	\$30.42	\$28.29	\$26.16	\$24.34	86
				Clamp/Solder	RG179, RG187	PE4906	\$37.45	\$34.83	\$32.21
Terminal		Solder	Solder Cup with .295 inch D Hole	PE4173	\$25.24	\$23.47	\$21.71	\$20.19	88
Jack Right Angle									
PCB Mount		Solder	Thru Hole with .200 inch x .067 inch Hole Spacing	PE4180	\$29.00	\$26.97	\$24.94	\$23.20	89

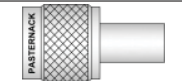
75 Ohm TNC Connectors



Connection Method	Product Image	Attachment Cable/Contact	Coax Type / Termination Type	Model No.	Price				ROW
					1-24	25-49	50-99	100 +	
Male									
Cable Connectors		Crimp/Solder	RG6	PE44162	\$18.79	\$17.47	\$16.16	\$15.03	90
			RG11*, RG144*, RG216*	PE44164	\$33.80	\$31.43	\$29.07	\$27.04	91
			RG179, RG187	PE44168	\$16.56	\$15.40	\$14.24	\$13.25	92
		Clamp/Solder	RG11*, RG144*, RG216*	PE44163	\$55.59	\$51.70	\$47.81	\$44.47	93
			RG59*	PE44165	\$16.26	\$15.12	\$13.98	\$13.01	94
Male Right Angle									
Cable Connectors		Clamp/Solder	RG59*, RG62*, RG71	PE44171	\$54.33	\$50.53	\$46.72	\$43.46	95
			RG179, RG187	PE44172	\$50.72	\$47.17	\$43.62	\$40.58	96

* Fits MIL-C-17 and equivalent cable versions only



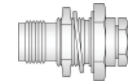

Connectors

See Our Website For Current Pricing & Real-Time Stock Availability!

75 Ohm TNC Connectors

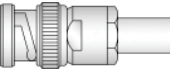
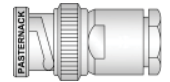
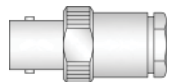
Connection Method	Product Image	Attachment Cable/Contact	Coax Type / Termination Type	Model No.	Price				ROW
					1-24	25-49	50-99	100 +	
Female, Bulkhead Mount									
Cable Connectors		Clamp/Solder	RG6 with .480 inch D Hole	PE44173	\$41.90	\$38.97	\$36.03	\$33.52	97
			RG179, RG187 with .480 inch D Hole	PE44176	\$41.92	\$38.99	\$36.05	\$33.54	98
Terminal		Solder	Solder Cup with .350 inch D Hole	PE44180	\$21.58	\$20.07	\$18.56	\$17.26	99
			Solder Cup with .480 inch D Hole	PE44181	\$24.38	\$22.67	\$20.97	\$19.50	1

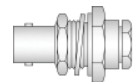
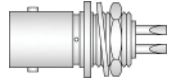
BNC Twinax Connectors

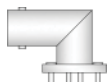
Connection Method	Product Image	Attachment Cable/Contact	Coax Type / Termination Type	Model No.	Price				ROW
					1-24	25-49	50-99	100 +	
Plug									
Cable Connectors		Crimp/Solder	RG108, 78 Ohm Twinax	PE4234	\$20.09	\$18.68	\$17.28	\$16.07	2
		Clamp/Solder	RG108, 78 Ohm Twinax	PE4236	\$25.92	\$24.11	\$22.29	\$20.74	3
Jack									
Cable Connectors		Clamp/Solder	RG108, 78 Ohm Twinax	PE4237	\$32.29	\$30.03	\$27.77	\$25.83	4
PCB Mount		Solder	Thru Hole with .687 inch x .500 inch Hole Spacing	PE44115	\$27.26	\$25.35	\$23.44	\$21.81	5
Jack, Bulkhead Mount									
Cable Connectors		Clamp/Solder	RG108, 78 Ohm Twinax with .480 inch D Hole	PE44114	\$44.03	\$40.95	\$37.87	\$35.22	6
Terminal		Solder	Solder Cup with .350 inch D Hole	PE4238	\$17.90	\$16.65	\$15.39	\$14.32	7
Jack, 4 Hole Flange Mount									
Terminal		Solder	Solder Cup with .500 inch Threaded Hole Spacing	PE4324	\$26.78	\$24.91	\$23.03	\$21.42	8
Jack Right Angle									
PCB Mount		Solder	Thru Hole with .687 inch x .500 inch Hole Spacing	PE44116	\$42.26	\$39.30	\$36.34	\$33.81	9

3/4"-20 Twinax Connectors

Connection Method	Product Image	Attachment Cable/Contact	Coax Type / Termination Type	Model No.	Price				ROW
					1-24	25-49	50-99	100 +	
Male									
Cable Connectors		Clamp/Solder	PE-S330	PE4104	\$23.02	\$21.41	\$19.80	\$18.42	10

* Fits MIL-C-17 and equivalent cable versions only



Free Shipping Available
via UPS Ground to
USA & Canada



Technical Support
(866) 727-8376





Same-Day Shipping,
Even Custom
Cable Assemblies

Connectors

See Our Website For Current Pricing & Real-Time Stock Availability!

3/4"-20 Twinax Connectors

Connection Method	Product Image	Attachment Cable/Contact	Coax Type / Termination Type	Model No.	Price				ROW
					1-24	25-49	50-99	100 +	
Female, Bulkhead Mount									
Terminal		Solder	Solder Cup with .720 inch D Hole	PE4105	\$23.90	\$22.23	\$20.55	\$19.12	11
Female, 4 Hole Flange Mount									
Terminal		Solder	Solder Cup with .718 inch Hole Spacing	PE4347	\$28.42	\$26.43	\$24.44	\$22.74	12

* Fits MIL-C-17 and equivalent cable versions only

CONNECTOR DUST CAPS

Non-Shorting Caps

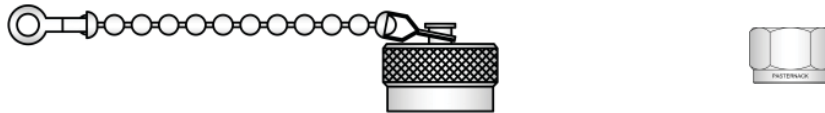

Connector	Gender	Compatible With	Chain	Model No	1-24	25-49	50-99	100+	ROW
7/16 DIN	Male	50 Ohm	Yes	PE6057	\$41.63	\$38.72	\$35.80	\$33.30	13
	Female		Yes	PE6058	\$47.85	\$44.50	\$41.15	\$38.28	14
BNC	Male		Yes	PE6013	\$7.93	\$7.37	\$6.82	\$6.34	15
			No	PE6014	\$4.43	\$4.12	\$3.81	\$3.54	16
	Female		Yes	PE6015	\$6.47	\$6.02	\$5.56	\$5.18	17
C	Male		No	PE6108	\$10.28	\$9.56	\$8.84	\$8.22	18
			Yes	PE6046	\$20.06	\$18.66	\$17.25	\$16.05	19
	Female		No	PE6109	\$23.17	\$21.55	\$19.93	\$18.54	20
			Yes	PE6110	\$25.77	\$23.97	\$22.16	\$20.62	21
F	Male		No	PE6111	\$21.69	\$20.17	\$18.65	\$17.35	22
			No	PE6240	\$3.01	\$2.80	\$2.59	\$2.41	23
			Yes	PE6059	\$26.43	\$24.58	\$22.73	\$21.14	24
HN	Female		No	PE6113	\$19.07	\$17.74	\$16.40	\$15.26	25
			Yes	PE6114	\$25.64	\$23.85	\$22.05	\$20.51	26
	Male		No	PE6115	\$26.16	\$24.33	\$22.50	\$20.93	27
N	Male		Yes	PE6016	\$6.61	\$6.15	\$5.68	\$5.29	28
			No	PE6017	\$7.19	\$6.69	\$6.18	\$5.75	29
	Female		Yes	PE6018	\$9.89	\$9.20	\$8.51	\$7.91	30
			No	PE6116	\$7.98	\$7.42	\$6.86	\$6.38	31
SC	Male		Yes	PE6117	\$37.55	\$34.92	\$32.29	\$30.04	32
	Female	Yes	PE6118	\$29.46	\$27.40	\$25.34	\$23.57	33	
SMA	Male	Yes	PE6019	\$10.60	\$9.86	\$9.12	\$8.48	34	
		No	PE6024	\$3.35	\$3.12	\$2.88	\$2.68	35	
	Female	Yes	PE6119	\$21.06	\$19.59	\$18.11	\$16.85	36	
		No	PE6120	\$8.09	\$7.52	\$6.96	\$6.47	37	

Connectors

See Our Website For Current Pricing & Real-Time Stock Availability!

Non-Shorting Caps

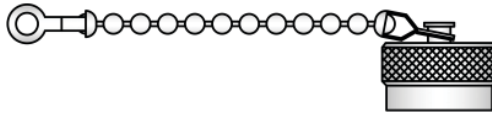

Connector	Gender	Compatible With	Chain	Model No	1-24	25-49	50-99	100+	ROW
SMB	Plug	50 Ohm	Yes	PE6121	\$23.97	\$22.29	\$20.61	\$19.18	38
		75 Ohm	Yes	PE6125	\$37.69	\$35.05	\$32.41	\$30.15	39
SMB	Jack	50 Ohm	Yes	PE6122	\$20.04	\$18.64	\$17.23	\$16.03	40
			Yes	PE6123	\$15.63	\$14.54	\$13.44	\$12.50	41
SMC	Plug	75 Ohm	Yes	PE6126	\$32.70	\$30.41	\$28.12	\$26.16	42
			Yes	PE6124	\$15.63	\$14.54	\$13.44	\$12.50	43
SSMA	Male	50 Ohm	No	PE6020	\$14.73	\$13.70	\$12.67	\$11.78	44
TNC			Yes	PE6023	\$9.23	\$8.58	\$7.94	\$7.38	45
			No	PE6144	\$8.45	\$7.86	\$7.27	\$6.76	46
TNC			Female	Yes	PE6021	\$11.18	\$10.40	\$9.61	\$8.94
	No	PE6143		\$11.64	\$10.83	\$10.01	\$9.31	48	

Shorting Caps

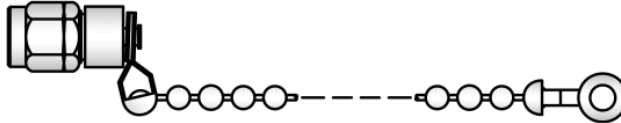
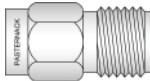

Connector	Gender	Compatible With	Chain	Model No	1-24	25-49	50-99	100+	ROW
2.4mm	Male	50 Ohm	Yes	PE6194	\$54.01	\$50.23	\$46.45	\$43.21	49
			Yes	PE6195	\$65.05	\$60.50	\$55.94	\$52.04	50
			No	PE6193	\$61.73	\$57.41	\$53.09	\$49.38	51
BNC	Male	50 Ohm	Yes	PE6127	\$19.64	\$18.27	\$16.89	\$15.71	52
			No	PE6012	\$7.30	\$6.79	\$6.28	\$5.84	53
			Yes	PE6128	\$22.88	\$21.28	\$19.68	\$18.30	54
BNC	Female	50 Ohm	No	PE6030	\$13.50	\$12.56	\$11.61	\$10.80	55
			Yes	PE6129	\$26.04	\$24.22	\$22.39	\$20.83	56
			No	PE6022	\$19.54	\$18.17	\$16.80	\$15.63	57
N	Male	50 Ohm	Yes	PE6130	\$41.61	\$38.70	\$35.78	\$33.29	58
			No	PE6031	\$9.26	\$8.61	\$7.96	\$7.41	59
			Yes	PE6131	\$26.64	\$24.78	\$22.91	\$21.31	60
SMA	Male	50 Ohm	No	PE6006	\$20.54	\$19.10	\$17.66	\$16.43	61
			Yes	PE6132	\$27.29	\$25.38	\$23.47	\$21.83	62
			Yes	PE6251	\$23.48	\$21.84	\$20.19	\$18.78	63
SMA	Female	50 Ohm	No	PE6007	\$22.32	\$20.76	\$19.20	\$17.86	64
			Yes	PE6134	\$25.47	\$23.69	\$21.90	\$20.38	65
			No	PE6133	\$21.46	\$19.96	\$18.46	\$17.17	66
TNC	Male	50 Ohm	Yes	PE6136	\$24.56	\$22.84	\$21.12	\$19.65	67
			No	PE6135	\$20.09	\$18.68	\$17.28	\$16.07	68
			Female	Yes	PE6135	\$20.09	\$18.68	\$17.28	\$16.07

Connectors

See Our Website For Current Pricing & Real-Time Stock Availability!



Free Shipping Available via UPS Ground to USA & Canada



Technical Support (866) 727-8376



Same-Day Shipping, Even Custom Cable Assemblies

PASTERNAK ENTERPRISES -- REACH PRODUCT COMPLIANCE PROGRAM

What is REACH Compliance?

Regulation (EC) No. 1907/2006 of the European Parliament and of the Council of 18 December 2006 is commonly referred to as REACH (Registration, Evaluation, Authorization, and Restriction of Chemicals). The REACH regulation became effective on June 1, 2007 to streamline and improve the former legislative framework for chemicals available in the European Union (EU) and European Economic Area (EEA) countries.

The objective of REACH is to improve protection of human health and the protection of the environment from the exposure to chemicals. REACH compliance is mandatory for products manufactured in, or imported into the European Union (EU).

As outlined by the REACH regulation, any organization manufacturing, importing, using or placing a substance, mixture, article or product on the EU market will be responsible for ensuring that the component substances are in compliance with REACH regulations.

Determining REACH Compliance of Pasternack Products:

Pasternack Enterprises does not currently either manufacture or import any chemical substances into the EU on their own or in articles (products) in quantities of 1 ton or more per year. In addition, products imported by Pasternack Enterprises' customers do not contain chemical substances intended to be released during the normal and reasonably foreseeable conditions of the product's use as defined by the REACH regulation and existing guidance.

However, under REACH, there is an obligation to ensure that articles do not contain <0.1% by weight of Substances of Very High Concern (SVHCs). SVHCs are substances that may cause cancer or other serious health or environmental effects and thus face restriction or outright bans, and are listed in a regularly-updated 'Candidate list'. The current Candidate list can be downloaded from the European Chemicals Agency (ECHA) website:

http://echa.europa.eu/chem_data/authorisation_process/candidate_list_table_en.asp

For each part that has been found to comply with the REACH SVHC reporting requirements, we show an indication of compliance adjacent to the part number using this symbol:



All products displaying this symbol on our website are assured to contain no SVHCs as defined by the Candidate List displayed on the Pasternack REACH certificate. When you locate the product you need on our website, please click on the "Product ID or Part Number". You will see the "REACH symbol" for the specific part. Click on this symbol to view the Certificate of REACH Compliance (printable if needed) for the specific product as well as the applicable ECHA SVHC Candidate list Date.

Pasternack Enterprises - REACH Product Compliance Program:

At Pasternack Enterprises, we recognize our responsibility as a worldwide supplier of RF, Microwave and Fiber Optic Products subject to the REACH regulations. We have completed a comprehensive effort internally and with our supply chain to determine the REACH compliance of our products. You will find our Reach Symbol adjacent to all products on our website that have been determined by Pasternack and our supply chain to contain less than 0.1% by weight of the REACH substances. You will also see the applicable ECHA SVHC Candidate List Date. "Please refer to our website at www.Pasternack.com.

The Pasternack Enterprises REACH Product Compliance Program is implemented in accordance with Regulation No. 1907/2006 of the European Parliament and the Council of 18 December 2006. Pasternack has implemented a REACH compliance program to address this legislation. Pasternack Enterprises does not currently either manufacture or import any chemical substances into the EU on their own or in articles (products) in quantities of 1 ton or more per year. In addition, products imported by Pasternack Enterprises' customers do not contain chemical substances intended to be released during the normal and reasonably foreseeable conditions of the product's use as defined by the REACH regulation and existing guidance. Thus, Pasternack Enterprises does not currently have a direct REACH obligation to pre-register substances. Pasternack's REACH Product Compliance is determined by a certification from our supply chain. A Pasternack product is deemed to be REACH compliant when it does not contain Substances of Very High Concern (SVHCs) beyond the specified concentration limits of less than 0.1% by weight as outlined in REACH 1907/2006/EU regulation.

Need More Information?

If you have questions regarding REACH Product Certification on Pasternack's products, please contact the Pasternack REACH Compliance Team via email at REACH@Pasternack.com or by calling Toll-Free within North America at 1-866-PASTERNAK (1-866-727-8376). International customers, please call +1-949-261-1920.



Free Shipping Available
via UPS Ground
to USA & Canada



Technical
Support
(866) 727-8376



Same-Day Shipping,
Even Custom
Cable Assemblies

PASTERNAK ENTERPRISES ROHS COMPLIANCE PROGRAM

Lead-free solder is now available for all cable assemblies upon request or online at www.Pasternack.com.

Our Commitment

At Pasternack, we recognize our responsibility as an international supplier of RF, Microwave and Millimeter wave electronics products to maintain a comprehensive RoHS compliance program. We are fully committed to offering RoHS compliance on the majority of our products and posting accurate RoHS compliance status for all of our products. We have posted this data on our website so that it can be easily found for each part number within our on-line catalogue.

What is RoHS Compliance?

The European Union set forth the RoHS (Restriction of Hazardous Substances) Directive to establish environmental guidelines and legislation to reduce the presence of six (6) materials deemed hazardous to the environment. To comply, products entering the EU must not have a homogeneous presence of these materials above the following levels by weight percentage

- Lead (Pb) < 0.1%
- Mercury (Hg) < 0.1%
- Cadmium (Cd) < 0.01%
- Hexavalent Chromium (CrVI) < 0.1%
- Polybrominated Biphenyls (PBB) < 0.1%
- Polybrominated Diphenyl Esters (PBDE) < 0.1%

Determining Pasternack RoHS Compliance

All products displaying this symbol on our website have been certified as RoHS Compliant. Click on the symbol to view the Certificate of RoHS Compliance for that product.



Lead Free Cable Assemblies

Many of Pasternack's cable assemblies are built with leaded solder. If so, the part will not be RoHS compliant and a certificate will not be found on the product page for that assembly. However, many of these assemblies can be brought into RoHS compliance through the use of Lead-Free solder. If the assembly you desire is not RoHS compliant, there may be a RoHS compliant version with a similar part number. If so, you will see an "LF" contained in the basic part number (example PE3067LF-24 is the lead free version of PE3067-24). Please note: the "LF" designation is used only when the base part number is not RoHS compliant. Many assemblies do not include "LF" and are compliant because they are only offered in a RoHS compliant configuration.

For More Information

Please direct any questions to Pasternack Enterprises Technical Support via email at TechSupport@Pasternack.com or by calling Toll-Free within North America at 1-866-PASTERNAK (866-727-8376). International customers, please use +1-949-261-1920.

MAILING LIST CHANGES

If you receive more than one RF Product Guide with the same name and address, please notify Pasternack and pass the RF Product Guide along to a friend. Also, if you do not require multiple copies to the same company address, contact a sales representative to verify and modify your mailing information. A forms-based communications method to add, delete or modify mailing information is available at www.pasternack.com. By clicking "Contact Us", and then clicking "Remove Name from Mailing List", you may complete the form to request a change to your mailing preferences. In addition, by clicking "RF Product Guide", and then clicking "Request a Printed RF Product Guide", you may add your contact information to our mailing list. Please note service opt-in and opt-out options located on the forms. Alternatively, you may mail, email, telephone or fax Pasternack your request.

PLACING YOUR ORDER

► **By Telephone: 866-PASTERNAK (866-727-8376)
US & Canada, or 949-261-1920**

Our friendly sales representatives are ready to serve you from 5:00am to 5:30pm Pacific Standard Time (PST), Monday through Friday. For the most efficient service, please have ready a list of quantities and part numbers and, if paying by credit card, your MasterCard, VISA, American Express or Discover card. Note: Calls may be recorded or monitored for quality and training purposes.

► **By Fax: 949-261-7451**

Our fax lines can be accessed 7 days a week, 24 hours a day. Orders received after 4:00pm PST will be promptly processed and shipped the next business day. Please include your daytime phone number and/or email address in case we have any questions about your order.

► **By Internet: www.Pasternack.com
or Email: sales@pasternack.com**

Order online 7 days a week, 24 hours a day using our online ordering system. Just search for the items you want and add them to your shopping cart. Internet orders entered after 4:00 pm PST will be promptly processed and shipped the next business day.

► **By Mail: Simply Mail Your Order To:
Pasternack Enterprises, Inc.
17802 Fitch
PO Box 16759
Irvine, CA 92623-6759 USA**

International customers, please see "International Orders" below for additional information.

Terms and Conditions of Sale:

The following from Pasternack's Binding Terms and Conditions of Sale are provided for your convenience. A complete documentation of the Binding Terms and Conditions of Sale may be found in the back of the RF Product Guide, or on Pasternack's website at <http://www.pasternack.com/t-terms-of-sale.aspx>. Any questions or clarifications may be answered by contacting Customer Service at (+1) 949-261-1920 or by any of the methods listed above.

No Minimum Order Requirement

Ground Freight is Free:

On UPS Ground orders, there is no charge for shipping for USA & Canada orders of \$100.00 or greater. Otherwise, shipping or freight charges and insurance will be paid by the customer. All sales are made FOB Point (as defined by the INCOTERMS 2000) in Irvine, CA USA. Shipping or freight charges from Pasternack's Irvine, CA factory are prepaid and added to the invoice or billed collect.

Same-Day Shipment:

Same-day shipment will apply to orders received Monday through Friday, prior to 4:00pm PST.

- All UPS air and surface options
- All FedEx air options (with an approved account number)
- Most other shipping options, including DHL (with an approved account number) and USPS

Counter-to-Counter Shipping:

For your urgent order requiring our fastest shipping method, we will place your order on the next available flight from Santa Ana-Orange County John Wayne International Airport (Airport code: SNA) to the destination you specify. Please call for details.

Payment Terms:

Pasternack offers a number of convenient payment methods:

For United States customers, we offer check, money order, MasterCard, VISA, American Express, Discover, and C.O.D. as well as open account credit to qualified institutions and businesses. Payment must be made in US Dollars.

For Canadian customers, we offer all of the above payment options except C.O.D.

For International customers, see **International Orders**.

Open Account Credit:

Net 30 Days terms are available to businesses, schools and agencies subject to credit approval. Approval can begin by submitting a completed Credit Application, which can be found online at:

www.Pasternack.com/t-CreditApplication.aspx

EFT/Wire Transfers:

Please contact us for details. We will inform you of the total amount which will include shipping charges and any applicable wire transfer fees. Orders will not be accepted until funds have been received in full.

WELLS FARGO BANK
420 Montgomery St.
San Francisco, CA 94104 USA
Account Number: 4270 0000 0000 0000 1
Routing Number: 121000248
SWIFT Number: WFBUS6S

International Orders:

In addition to the United States and its territories, Pasternack accepts international orders. All orders of international origin are exported from the US in accordance with the Export Administration Regulations. Diversion contrary to US Law is prohibited. Please see Pasternack's Binding Terms and Conditions of Sale for full details.

Pasternack has international distributors for the following countries:

Africa: Namibia, South Africa

Asia-Pacific: Australia, China PRC, India, Indonesia, Japan, Malaysia, New Zealand, Singapore, South Korea, Thailand

Europe: Austria, Belgium, Czech Republic, Denmark, Finland, France, Germany, Ireland, Italy, Kazakhstan, Luxembourg, Netherlands, Norway, Poland, Portugal, Russia, Slovakia, Spain, Sweden, Switzerland, Turkey, United Kingdom

Middle East: Israel

South America: Brazil

To access their complete contact information, please see our International Distributors section in this RF Product Guide. (inside back cover)

International Shipping Charges:

Shipping or freight charges and insurance will be paid by the customer. All sales are made FOB Point (as defined by the INCOTERMS 2000) in Irvine, CA USA. We ship orders by UPS, FedEx (with an approved account number), or DHL (with approved account number) with delivery in 2 to 3 days to most locations worldwide.

International Taxes and Duties:

Customer is responsible for duties and taxes.



Free Shipping Available
via UPS Ground
to USA & Canada



Technical
Support
(866) 727-8376



Same-Day Shipping,
Even Custom
Cable Assemblies

BINDING TERMS AND CONDITIONS OF SALE

The following are the terms and conditions ("Terms and Conditions") for the sale of products ("Products") by Pasternack Enterprises, Inc. ("Pasternack") to Pasternack's customers ("Customers"). Please read this agreement carefully. Any different or additional terms set forth in customer's purchase order or similar communication are objected to and shall not be binding on the company unless a separate agreement has been signed by an authorized officer of the company. By placing an order for products from the company, or by accepting delivery of the products described on the applicable packing slip, bill of lading and/or invoice received with the products, you agree to be bound by and accept these terms and conditions of sale.

1. ACCEPTANCE AND CANCELLATION OF ORDERS

All orders are subject to acceptance by Pasternack in writing by a duly authorized agent of Pasternack; any written acknowledgement of receipt of an order shall not, in and of itself, constitute such acceptance. Orders accepted and processed by Pasternack may not be cancelled by Customer except as covered by the Limited Warranty. All sales are final. Cable Assemblies and Non-Standard Products are also Non-Cancelable/Non-Refundable ("NC/NR"). Non-Standard Parts are defined as Products which are special orders, custom orders, orders for non-standard products, products not customarily in stock or orders for value-added products. In the event of cancellation or other withdrawal of an order for any reason and without limiting any other remedy which Pasternack may have as a result of such cancellation or other withdrawal, reasonable cancellation or restocking charges, which shall include all expenses then incurred and commitments made by Pasternack, shall be paid by Customer to Pasternack. Customer requests to reschedule are subject to acceptance by Pasternack in its sole discretion. Orders may not be rescheduled after the order has been submitted by Pasternack to the shipment carrier.

2. PRICES

Orders are billed at the prices (in US dollars) in effect at the time of shipment. Prices will be as specified by Pasternack and will be applicable for the period specified in Pasternack's quote. If no period is specified, quoted prices will be applicable for thirty (30) days. The website contains the most current pricing and is the price reference for orders. Pricing included in the catalog is for reference only and final pricing is determined by the published website price. Prices shown in the RF Product Guide (Catalog) and on the website are subject to change without notice. Prices are exclusive of taxes, impositions and other charges, including: sales, use, excise, value added and similar taxes or charges imposed by any government authority, international shipping charges, forwarding agent's and broker's fees, bank fees, consular fees, document fees and import duties.

3. TERMS OF PAYMENT

All payments must be in US Dollars, or will be converted to US Dollars using the available exchange rate at the time of purchase.

MasterCard, VISA, Discover, and American Express credit cards, purchase cards and major bank debit cards are accepted. Payment via net thirty (30) days is available to businesses, schools and agencies or as otherwise specified by Pasternack subject to credit approval.

For International Orders

MasterCard, VISA, and American Express credit cards are accepted. Payment via open credit account with Net thirty (30) days may be established for companies having three U.S. references accepted to Pasternack. Prepaid Wire Transfer: You can wire the funds to our bank. We will contact you with the total amount, which will include shipping charges and a \$40 wire transfer fee. Orders will not be accepted until funds have been received in full and the Purchase Order (PO) has been received. Customer is responsible for sales, use, excise, value added and similar taxes or charges imposed by any government authority, international shipping charges, forwarding agent's and broker's fees, bank fees, consular fees, document fees and import duties.

4. SALES TAX

California residents are required to remit sales tax. Pasternack does not remit sales tax to states other than California. Any sales tax due that is not collected by Pasternack is the responsibility of the customer.

5. TOLERANCES

All coaxial cable assemblies displayed in the Pasternack catalog and website have a standard cable length tolerance of $\pm 1.5\%$ or 3/8 inches (0.375"), whichever is greater. Cable Assemblies in excess of this tolerance factor are eligible for repair and/or replacement under the terms of the Pasternack Limited Warranty.

6. DELIVERY AND TITLE

Shipping or freight charges and insurance will be paid by the customer. All sales are made FCA Shipping Point (as defined by the INCOTERMS 2000) in Irvine, CA USA. Shipping or freight charges from Pasternack's Irvine, CA facility are prepaid and added to the invoice, or billed collect. Subject to Pasternack's right of stoppage in transit, delivery of the Products to the carrier will constitute delivery to Customer and title and risk of loss will pass to Customer. Pasternack will make reasonable efforts to initiate shipment and schedule delivery as close as possible to Customer's requested delivery date(s). Customer acknowledges that delivery dates provided by Pasternack are estimates only and that Pasternack will not be liable for failure to deliver on such dates. Selection of the carrier and delivery route will be made by Pasternack unless specifically designated by Customer. Pasternack reserves the right to make deliveries in installments. Delay in delivery of one installment will not entitle Customer to cancel any other installment(s). Delivery of any installment of Products within thirty (30) days after the date requested will constitute a

timely delivery. Delivery of a quantity that varies from the quantity specified shall not relieve Customer of the obligation to accept delivery and pay for the Products delivered.

7. PASTERNAK'S LIMITED WARRANTY

All products are covered by a LIMITED WARRANTY for a period of one (1) year from the date of shipment when purchased from Pasternack Enterprises, Inc. Customer must notify Pasternack within one (1) year from date of shipment of any defective product. An approved Return Material Authorization (RMA) number must first be obtained from Pasternack prior to the return of any merchandise to Pasternack for inspection under warranty. Shipping charges for all materials returned under this Limited Warranty are to be prepaid by the Customer. This warranty is limited to the original purchaser. Pasternack's liability arising out of any sale of products to Customer is expressly limited to either (1) Credit for the purchase price paid by Customer for such products (without interest), or (2) Repair and/or replacement of such products, found to be defective after inspection by Pasternack, and such remedies shall be exclusive and in lieu of all others. THIS WARRANTY IS IN LIEU OF ANY AND ALL OTHER WARRANTIES, WHETHER ORAL, WRITTEN, EXPRESSED, IMPLIED OR STATUTORY. ANY IMPLIED WARRANTIES OF MERCHANTABILITY, FITNESS FOR A PARTICULAR PURPOSE AND NON-INFRINGEMENT ARE HEREBY DISCLAIMED. Further, no warranty will apply if the Product has been subject to misuse, neglect, accident or modification, or has been soldered or altered in any way.

All returns must be shipped to: Pasternack Enterprises, Inc.
17802 Fitch
Irvine, CA 92614 USA

8. LIMITATION OF LIABILITIES

In no event shall Pasternack be liable for any special, incidental or consequential damages of any nature including, but not limited to, damages resulting from loss of profit or revenue, recall costs, claims for service interruptions or failure to supply downtime, testing, installations or removal costs, costs of substitute products, property damage, personal injury, death or legal expenses. Customer's recovery from Pasternack for any claim shall not exceed the purchase price paid by Customer for the goods, irrespective of the nature of the claim, whether in warrant, contract or otherwise. CUSTOMER SHALL INDEMNIFY, DEFEND AND HOLD PASTERNAK HARMLESS FROM ANY CLAIMS brought by any party regarding products supplied by Pasternack and incorporated into the customer's product.

9. STATEMENTS AND ADVICE

If statements or advice, technical or otherwise, are offered or given to Customer, such statements or advice will be deemed to be given as an accommodation to Customer and without charge and Pasternack shall have no responsibility or liability for the content or use of such statements or advice.

10. EXPORT CONTROL AND EMBARGOES

Products purchased or received under these Terms and Conditions are subject to export control and economic sanctions laws, restrictions, regulations and orders of the United States. Customer agrees to comply with all applicable export control laws, restrictions and regulations of the United States and shall not export, or transfer for the purpose of re-export, any product to any embargoed country or region, including but not limited to Cuba, the Crimean Region of Ukraine, Iran, North Korea, Sudan, and Syria, or to any denied, blocked, or designated person or entity as mentioned in any such United States or foreign law or regulation. Customer represents and warrants that it is not on the Denied Persons, Specially Designated Nationals or Debarred Persons List (as identified by the U.S. Treasury Office of Foreign Asset Control (OFAC) and by the U.S. Department of Commerce, Bureau of Industry and Security (BIS), or any other United States list of prohibited persons; is not owned or controlled by any person that is on one of those lists, or is otherwise prohibited by United States or other law from purchasing the products or services hereunder. Customer shall be solely responsible to obtain any license to export, re-export or import as may be required. Customer also agrees that it will not use these products in connection with the proliferation of weapons of mass destruction, including missiles, nuclear, chemical or biological weapons.

11. GENERAL

The Terms and Conditions may not be modified or cancelled without Pasternack's written agreement. Accordingly, goods furnished and services rendered by Pasternack are sold only on the terms and conditions stated herein. The Terms and Conditions will be governed by and construed in accordance with the laws of the State of California and the applicable laws of the United States of America. If Customer chooses to access the Pasternack website from outside the United States, Customer does so on their own initiative and is responsible for compliance with all applicable local laws.

12. INTELLECTUAL PROPERTY

The drawings, text, product depictions, logos, content, product descriptions, and organization and taxonomy of Pasternack's RF Product Guide and website and of the described content within the RF Product Guide and website are proprietary to Pasternack and protected by intellectual property laws, including but not limited to United States Copyright law and United States Trademark law. Pasternack owns copyrights in these referenced works as well as the selection, arrangement, coordination and structure of the arranged content and works within their RF Product Guide and website. Use of the RF Product Guide/website does not give you any right to modify, reproduce, transmit, publish, publicly display, adapt, or create derivative works or in any way exploit any of the materials and content of Pasternack's RF Product Guide or website.

WARNING: Products in this catalog can expose you to chemicals including phthalates, which are known to the State of California to cause cancer and birth defects or other reproductive harm. For more information, go to www.P65Warnings.ca.gov. For specific products impacted, please visit www.pasternack.com.

50-OHM CONVERSION TABLE

(dBm - volts- watts)

dBm	V	Po
+53	100.0	200W
+50	70.7	100W
+49	64.0	80W
+48	58.0	64W
+47	50.0	50W
+46	44.5	40W
+45	40.0	32W
+44	32.5	25W
+43	32.0	20W
+42	28.0	16W
+41	26.2	12.5W
+40	22.5	10W
+39	20.0	8W
+38	18.0	6.4W
+37	16.0	5W
+36	14.1	4W
+35	12.5	3.2W
+34	11.5	2.5W
+33	10.0	2W
+32	9.0	1.6W
+31	8.0	1.25W
+30	7.10	1.0W
+29	6.40	800 mW
+28	5.80	640 mW
+27	5.00	500 mW
+26	4.45	400 mW
+25	4.00	320 mW
+24	3.55	250 mW
+23	3.20	200 mW
+22	2.80	160 mW
+21	2.52	125 mW
+20	2.25	100 mW
+19	2.00	80 mW
+18	1.80	64 mW
+17	1.60	50 mW
+16	1.41	40 mW
+15	1.25	32 mW
+14	1.15	25 mW
+13	1.00	20 mW
+12	0.90	16 mW
+11	0.80	12.5 mW
+10	0.71	10 mW
+9	0.64	8 mW
+8	0.58	6.4 mW
+7	0.50	5 mW
+6	0.45	4 mW
+5	0.40	3.2 mW
+4	0.36	2.5 mW
+3	0.32	2.0 mW

dBm	V	Po
+2	0.28	1.6 mW
+1	0.25	1.25 mW
0	0.23	1.0 mW
-1	0.20	.80 mW
-2	0.18	.64 mW
-3	0.16	.50 mW
-4	0.14	.40 mW
-5	0.13	.32 mW
-6	0.12	.25 mW
-7	0.10	.20 mW
-8	0.09	.16 mW
-9	0.08	.125 mW
-10	0.07	.10 mW
-11	0.06	
-12	0.06	
-13	0.05	
-14	0.05	
-15	0.04	
-16	0.0355	
dBm	mV	Po
-17	31.5	
-18	28.5	
-19	25.1	
-20	22.5	.01 mW
-21	20.0	
-22	17.9	
-23	15.9	
-24	14.1	
-25	12.8	
-26	11.5	
-27	10.0	
-28	8.9	
-29	8.0	
-30	7.1	.001 mW
-31	6.25	
-32	5.8	
-33	5.0	
-34	4.5	
-35	4.0	
-36	3.5	
-37	3.2	
-38	2.85	
-39	2.5	
-40	2.25	.1 μ W
-41	2.0	
-42	1.8	
-43	1.6	
-44	1.4	
-45	1.25	

dBm	mV	Po
-46	1.18	
-47	1.0	
-48	0.9	
-49	0.8	
-50	0.71	.01 μ W
-51	0.64	
-52	0.57	
-53	0.5	
-54	0.45	
-55	0.4	
-56	0.351	
-57	0.32	
-58	0.286	
-59	0.251	
-60	0.225	.001 μ W
-61	0.2	
-62	0.18	
-63	0.16	
-64	0.141	
dBm	μ V	Po
-65	128	
-66	115	
-67	100	
-68	90	
-69	80	
-70	71	.1 nW
-71	65	
-72	58	
-73	50	
-74	45	
-75	40	
-76	35	
-77	32	
-78	29	
-79	25	
-80	22.5	.01 nW
-81	20	
-82	18	
-83	16	
-84	11.1	
-85	12.9	
-86	11.5	
-87	10.0	
-88	9.0	
-89	8.0	
-90	7.1	.001 nW
-91	6.1	
-92	5.75	
-93	5.0	

dBm	μ V	Po
-94	4.5	
-95	4.0	
-96	3.51	
-97	3.2	
-98	2.9	
-99	2.51	
-100	2.25	.1 pW
-101	2.0	
-102	1.8	
-103	1.6	
-104	1.41	
-105	1.27	
-106	1.18	
dBm	nV	Po
-107	1000	
-108	900	
-109	800	
-110	710	.01 pW
-109	640	
-112	580	
-113	500	
-114	450	
-115	400	
-116	355	
-117	825	
-118	285	
-119	251	
-120	225	.001 pW
-121	200	
-122	180	
-123	160	
-124	141	
-125	128	
-126	117	
-127	100	
-128	90	
-129	80	
-130	71	.1 fW
-131	61	
-132	58	
-133	50	
-134	45	
-135	40	
-136	35	
-137	33	
-138	29	
-139	25	
-140	23	.01 fW



Free Shipping Available
via UPS Ground to
USA & Canada



Technical
Support
(866) 727-8376



Same-Day Shipping,
Even Custom
Cable Assemblies

RETURN LOSS CONVERSION TABLE

Return Loss (dBm)	VSWR
46.064	1.01
40.086	1.02
36.607	1.03
34.151	1.04
32.256	1.05
30.714	1.06
29.417	1.07
28.299	1.08
27.318	1.09
26.444	1.10
25.658	1.11
24.943	1.12
24.289	1.13
23.686	1.14
23.127	1.15
22.607	1.16
22.120	1.17
21.664	1.18
21.234	1.19
20.828	1.20
20.443	1.21
20.079	1.22
19.732	1.23
19.401	1.24
19.085	1.25
18.783	1.26
18.493	1.27
18.216	1.28
17.949	1.29
17.690	1.30
17.445	1.31
17.207	1.32
16.977	1.33
16.755	1.34
16.540	1.35
16.332	1.36
16.131	1.37
15.936	1.38
15.747	1.39
15.563	1.40
15.385	1.41
15.211	1.42
15.043	1.43
14.879	1.44
14.719	1.45
14.564	1.46
14.412	1.47
14.264	1.48
14.120	1.49
13.979	1.50

Return Loss (dBm)	VSWR
13.842	1.51
13.708	1.52
13.577	1.53
13.449	1.54
13.324	1.55
13.201	1.56
13.081	1.57
12.964	1.58
12.849	1.59
12.736	1.60
12.625	1.61
12.518	1.62
12.412	1.63
12.308	1.64
12.207	1.65
12.107	1.66
12.009	1.67
11.913	1.68
11.818	1.69
11.725	1.70
11.634	1.71
11.545	1.72
11.457	1.73
11.370	1.74
11.285	1.75
11.202	1.76
11.120	1.77
11.039	1.78
10.960	1.79
10.881	1.80
10.804	1.81
10.729	1.82
10.654	1.83
10.581	1.84
10.509	1.85
10.437	1.86
10.367	1.87
10.298	1.88
10.230	1.89
10.163	1.90
10.097	1.91
10.032	1.92
9.968	1.93
9.904	1.94
9.842	1.95
9.780	1.96
9.720	1.97
9.660	1.98
9.601	1.99
9.542	2.00

Return Loss (dBm)	VSWR
9.485	2.01
9.428	2.02
9.372	2.03
9.317	2.04
9.262	2.05
9.208	2.06
9.155	2.07
9.103	2.08
9.051	2.09
8.999	2.10
8.949	2.11
8.899	2.12
8.849	2.13
8.800	2.14
8.752	2.15
8.705	2.16
8.657	2.17
8.611	2.18
8.565	2.19
8.519	2.20
8.474	2.21
8.430	2.22
8.386	2.23
8.342	2.24
8.299	2.25
8.257	2.26
8.215	2.27
8.173	2.28
8.138	2.29
8.091	2.30
8.051	2.31
8.011	2.32
7.972	2.33
7.933	2.34
7.894	2.35
7.856	2.36
7.818	2.37
7.781	2.38
7.744	2.39
7.707	2.40
7.671	2.41
7.635	2.42
7.599	2.43
7.564	2.44
7.529	2.45
7.494	2.46
7.460	2.47
7.426	2.48
7.393	2.49
7.360	2.50

Return Loss (dBm)	VSWR
7.327	2.51
7.294	2.52
7.262	2.53
7.230	2.54
7.198	2.55
7.167	2.56
7.135	2.57
7.105	2.58
7.074	2.59
7.044	2.60
7.014	2.61
6.984	2.62
6.954	2.63
6.925	2.64
6.896	2.65
6.867	2.66
6.839	2.67
6.811	2.68
6.783	2.69
6.755	2.70
6.728	2.71
6.700	2.72
6.673	2.73
6.646	2.74
6.620	2.75
6.594	2.76
6.567	2.77
6.541	2.78
6.516	2.79
6.490	2.80
6.465	2.81
6.440	2.82
6.415	2.83
6.390	2.84
6.366	2.85
6.341	2.86
6.317	2.87
6.293	2.88
6.270	2.89
6.246	2.90
6.223	2.91
6.200	2.92
6.177	2.93
6.154	2.94
6.131	2.95
6.109	2.96
6.086	2.97
6.064	2.98
6.042	2.99
6.021	3.00

Return Loss (dBm)	VSWR
5.999	3.01
5.970	3.02
5.956	3.03
5.935	3.04
5.914	3.05
5.893	3.06
5.872	3.07
5.852	3.08
5.832	3.09
5.811	3.10
5.791	3.11
5.771	3.12
5.751	3.13
5.732	3.14
5.712	3.15
5.693	3.16
5.674	3.17
5.654	3.18
5.635	3.19
5.617	3.20
5.598	3.21
5.579	3.22
5.561	3.23
5.542	3.24
5.524	3.25
5.506	3.26
5.488	3.27
5.470	3.28
5.452	3.29
5.435	3.30
5.417	3.31
5.400	3.32
5.383	3.33
5.365	3.34
5.348	3.35
5.331	3.36
5.315	3.37
5.298	3.38
5.281	3.39
5.265	3.40
5.248	3.41
5.232	3.42
5.216	3.43
5.200	3.44
5.184	3.45
5.168	3.46
5.152	3.47
5.137	3.48
5.121	3.49
5.105	3.50

MOUNTING HOLES

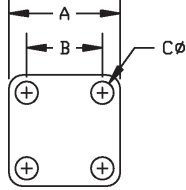

CODE	A	B	C
A01	.500	.340	.102
A02	.687	.500	.109
A03	.687	.500	#3-56 TAP
A04	.687	.500	.125
A05	1.000	.718	.125
A06	.750	.531	.140
A07	.750	.531	.125
A08	1.190	.906	.125
A09	.687	.500	#4-40 TAP
A10	.687	.500	.136
A11	1.250	.975	.147
A12	2.000	1.440	.257
A13	1.000	.718	.141
A14	1.000	.718	.144
A15	.687	.500	.104
A16	.750	.531	.136
A17	.375	.232	.067
A18	.625	.437	.094
A19	1.000	.718	#6-32 TAP
A20	.500	.340	#2-56 TAP
A21	1.250	.975	.142
A22	.375	.232	.093

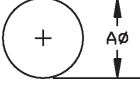

CODE	A
F01	.250
F02	.500
F03	.630
F04	1.200
F05	.380
F06	.450
F07	.200
F08	.362
F09	.220
F10	.317
F11	4.83mm
F12	.390

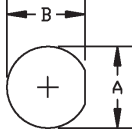

CODE	A	B
B01	.195	.177
B02	.250	.235
B03	.330	.295
B04	.380	.350
B05	.440	.410
B06	.512	.480
B07	.760	.720
B08	.565	.537
B09	.314	.296
B10	.140	.126
B11	.695	.655
B12	.625	.575
B13	.405	.361
B14	.277	.252
B15	.630	.596
B16	.317	.285
B17	.284	.268

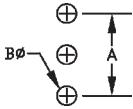

CODE	A	B
J01	.200	.046

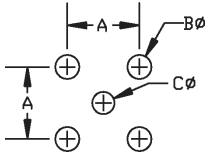

CODE	A	B	C
D01	.200	.067	.062
D02	.200	.067	.046
D03	.100	.031	.031
D04	.200	.052	.052
D05	.260	.067	.043
D06	.200	.052	.047
D07	.200	.055	.043
D08	.200	.067	.035
D09	.200	.055	.028
D10	.200	.055	.035
D11	.320	.091	.031
D12	.400	.062	.062
D13	.320	.091	.091
D14	.340	.091	.043
D15	.164	.067	.091
D16	.500	.126	.440
D17	.380	.083	.043

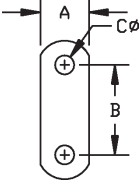

CODE	A	B	C
C01	.223	.481	.102
C02	.260	.481	.102
C03	.192	.328	.067
C04	.640	1.000	.125
C05	.275	.481	.102
C06	.230	.354	.067
C07	.188	.328	.093

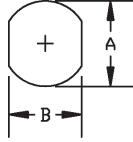

CODE	A	B
G01	.640	.546
G02	.380	.340
G03	.765	.712
G04	.362	.323
G05	.236	.197
G06	.217	.177
G07	.380	.310
G08	1.161	1.000

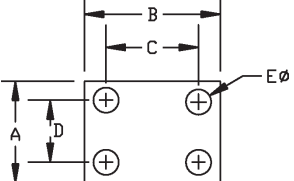

CODE	A	B	C	D	E
E01	.375	.500	.340	.222	.093

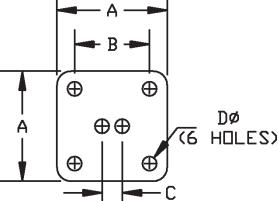

CODE	A	B	C	D
H01	.687	.500	.125	.045



Free Shipping Available
via UPS Ground to
USA & Canada



Technical
Support
(866) 727-8376



Same-Day Shipping,
Even Custom
Cable Assemblies

CONNECTOR IDENTIFIER

SPECIFICATIONS SHOWN ARE INTENDED FOR IDENTIFICATION PURPOSES ONLY

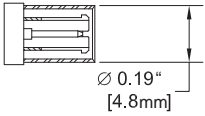
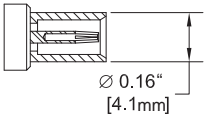
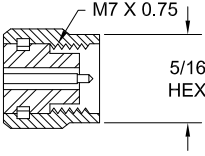
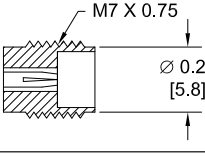
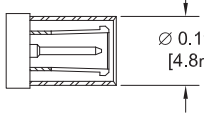
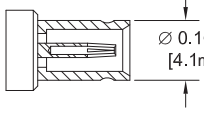
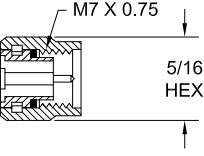
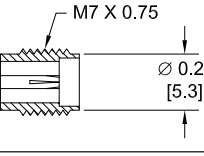
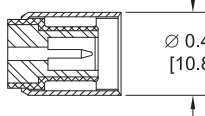
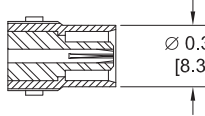
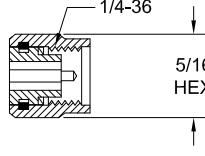
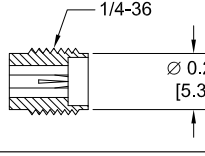
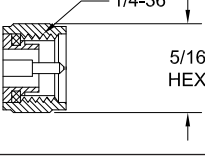
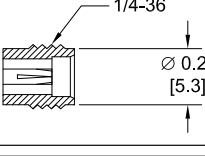
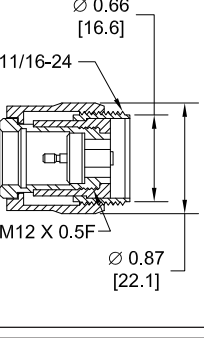
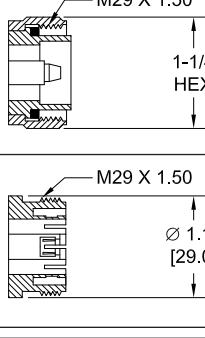
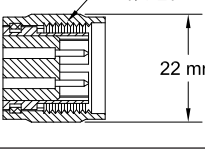
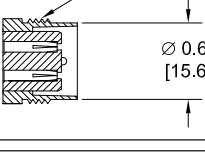
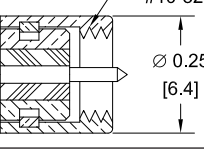
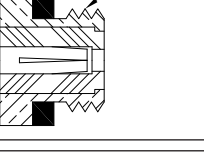
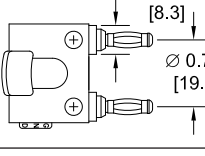
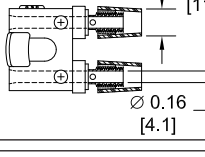
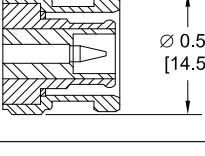
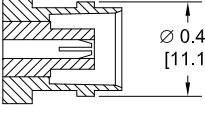
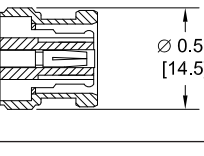
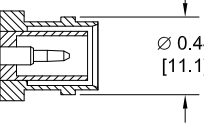
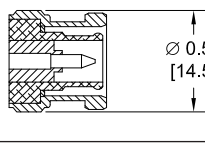
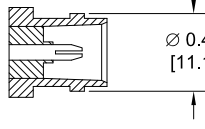









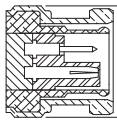
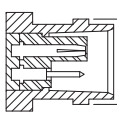
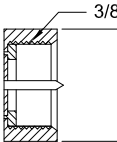
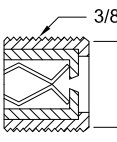
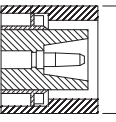
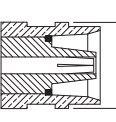
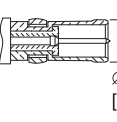
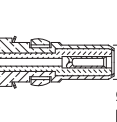
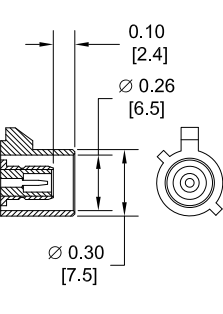
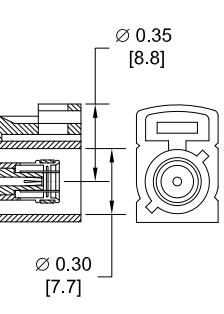





1.0/2.3 SLIDE ON	PLUG	
	JACK	
1.85 mm**	MALE	
	FEMALE	
1.0/2.3 SNAP ON	PLUG	
	JACK	
2.4 mm**	MALE	
	FEMALE	
1.6/56	PLUG	
	JACK	
2.92 mm**	MALE	
	FEMALE	
3.5 mm**	MALE	
	FEMALE	
7 mm	PLUG	
	JACK	
3/4-20 TWINAX	MALE	
	FEMALE	
10 - 32	MALE	
	FEMALE	
BANANA	PLUG	
	JACK	
BNC	MALE	
	FEMALE	
REVERSE POLARITY BNC	MALE	
	FEMALE	
75 OHM BNC	MALE	
	FEMALE	

*SMA, 2.92mm, & 3.5mm CONNECTORS WILL MATE MECHANICALLY & ELECTRICALLY TO EACH OTHER.

**1.85mm & 2.4mm CONNECTORS WILL MATE MECHANICALLY & ELECTRICALLY TO EACH OTHER.

CONNECTOR IDENTIFIER

SPECIFICATIONS SHOWN ARE INTENDED FOR IDENTIFICATION PURPOSES ONLY

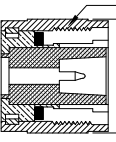
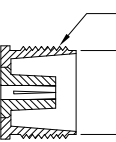
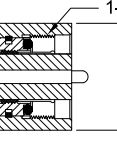
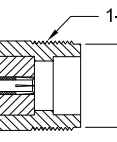
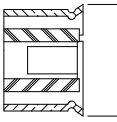
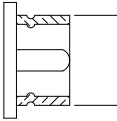
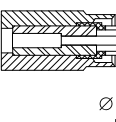
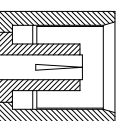
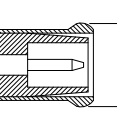
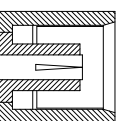
BNC TWINAX	PLUG	 Ø 0.57" [14.5mm]				
	JACK	 Ø 0.44" [11.1mm]				
F	MALE	 3/8-32 7/16 HEX				
	FEMALE	 3/8-32 Ø 0.34 [8.5]				
C	MALE	 Ø 0.75" [19.1mm]				
	FEMALE	 Ø 0.60" [15.2mm]				
D SUBMINIATURE	PLUG	 Ø 0.19" [4.8mm]				
	RECEPTACLE	 Ø 0.15" [3.9mm]				
FAKRA	PLUG	 0.10 [2.4] Ø 0.26 [6.5] Ø 0.30 [7.5]				
	JACK	 Ø 0.35 [8.8] Ø 0.30 [7.7]				
FAKRA	COMPLETE KEY CODE INFO	CODE	JACK	PLUG	COLOR	APPLICATION
		A			BLACK	RADIO WITH PHANTOM SUPPLY
		B			WHITE	RADIO WITHOUT PHANTOM SUPPLY
		C			BLUE	GPS: TELEMATICS OR NAVIGATION
D			BORDEAUX	GSM: CELLULAR PHONE		
H			VIOLET	GPS: TELEMATICS AND NAVIGATION		
I			BEIGE	BLUETOOTH		
K			CURRY	RADIO WITH I.F. OUTPUT (ANTENNA DIVERSITY)		
Z			WATER BLUE	NEUTRAL CODING		
GR874	MALE	 3/4-20 Ø 0.90 [22.9]				
	FEMALE	 3/4-20 Ø 0.67 [17.1]				
LC	MALE	 1-1/4-18 1-1/2 HEX				
	FEMALE	 1-1/4-18 Ø 1.17 [29.6]				
UMCX	PLUG	 Ø 0.10 [2.5]				
	JACK	 Ø 0.08 [2.0]				
MC-CARD	PLUG	 Ø 0.087 [2.2]				
	JACK	 Ø 0.20 [5.0]				
MCX	PLUG	 Ø 0.15 [3.7]				
	JACK	 Ø 0.20 [5.0]				



CONNECTOR IDENTIFIER

SPECIFICATIONS SHOWN ARE INTENDED FOR IDENTIFICATION PURPOSES ONLY

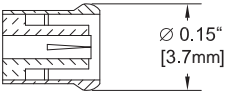
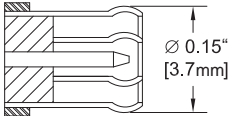
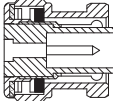
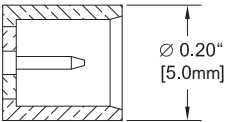
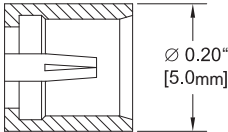
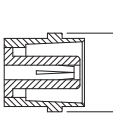
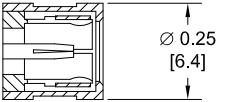
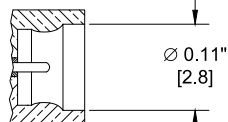
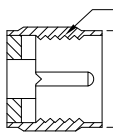
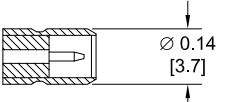
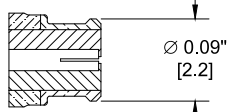
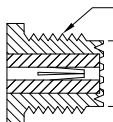
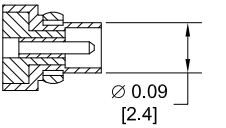
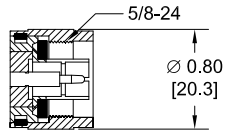
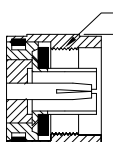
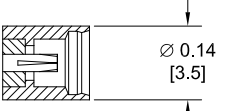
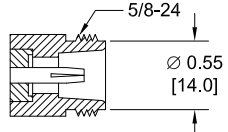
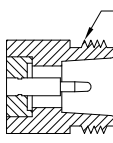
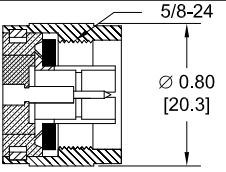
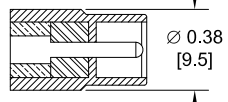
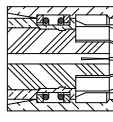
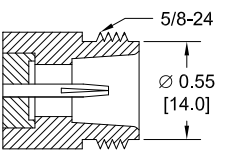
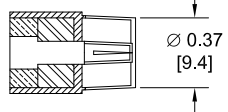
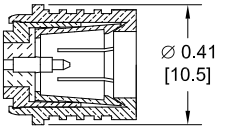
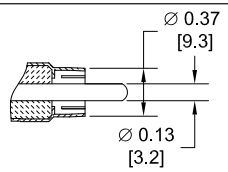
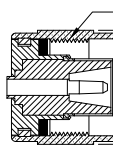
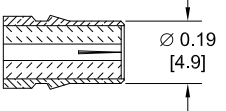
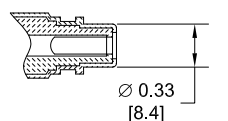
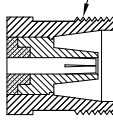
REVERSE POLARITY MCX	PLUG	 Ø 0.15" [3.7mm]	75 OHM MCX	PLUG	 Ø 0.15" [3.7mm]	MHV	MALE	 Ø 0.57" [14.5mm]
	JACK	 Ø 0.20" [5.0mm]		JACK	 Ø 0.20" [5.0mm]		FEMALE	 Ø 0.44" [11.1mm]
MINI 75 OHM SMB	PLUG	 Ø 0.25 [6.4]	MINI SMP	MALE	 Ø 0.11" [2.8]	MINI-UHF	MALE	 3/8-24 Ø 0.45 [11.5]
	JACK	 Ø 0.14 [3.7]		FEMALE	 Ø 0.09" [2.2]		FEMALE	 3/8-24 Ø 0.31 [7.8]
MMCX	PLUG	 Ø 0.09 [2.4]	N	MALE	 5/8-24 Ø 0.80 [20.3]	REVERSE POLARITY N	MALE	 5/8-24 Ø 0.80 [20.3]
	JACK	 Ø 0.14 [3.5]		FEMALE	 5/8-24 Ø 0.55 [14.0]		FEMALE	 5/8-24 Ø 0.55 [14.0]
75 OHM N	MALE	 5/8-24 Ø 0.80 [20.3]	PAL	PLUG	 Ø 0.38 [9.5]	POSITIVE SNAP	 Ø 0.39 [9.9]	
	FEMALE	 5/8-24 Ø 0.55 [14.0]		JACK	 Ø 0.37 [9.4]			
OMA	MALE	 Ø 0.41 [10.5]	RCA	PLUG	 Ø 0.37 [9.3] Ø 0.13 [3.2]	SC	MALE	 11/16-24 Ø 0.80 [20.3]
	FEMALE	 Ø 0.19 [4.9]		JACK	 Ø 0.33 [8.4]		FEMALE	 11/16-24 Ø 0.63 [15.9]

CONNECTOR IDENTIFIER

SPECIFICATIONS SHOWN ARE INTENDED FOR IDENTIFICATION PURPOSES ONLY

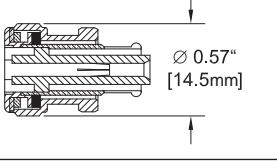
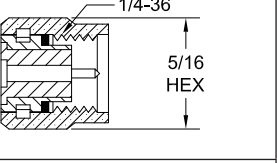
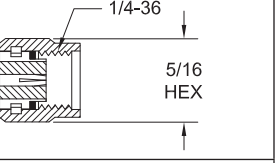
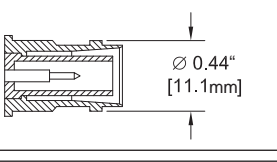
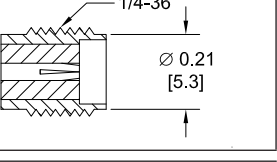
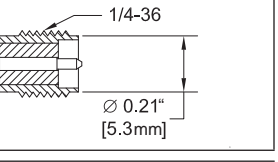
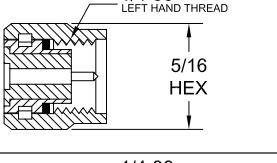
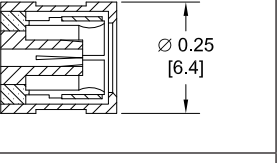
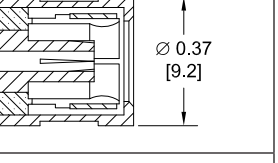
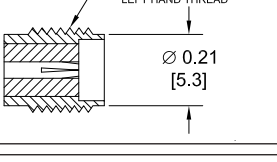
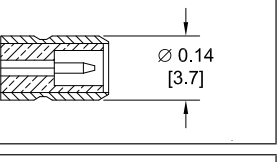
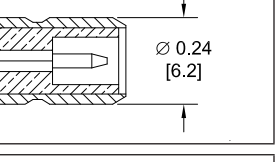
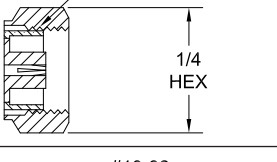
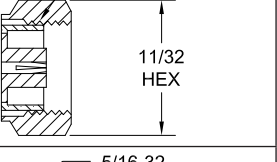
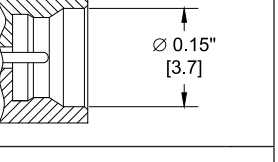
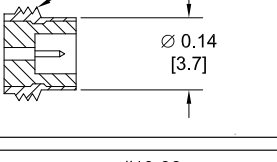
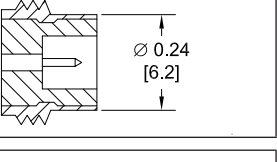
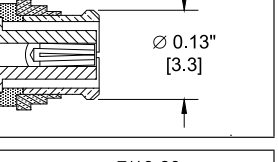
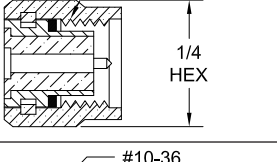
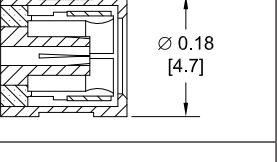
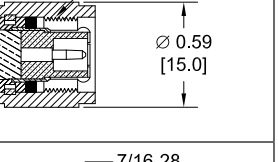
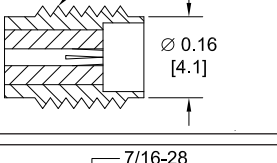
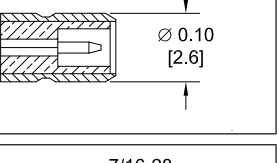
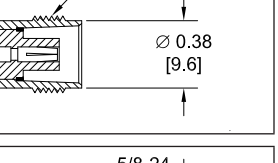
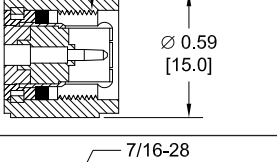
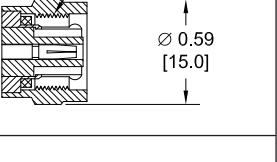
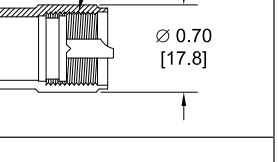
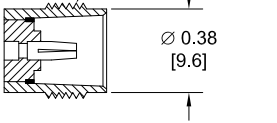
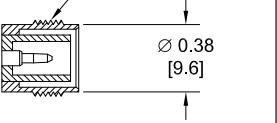
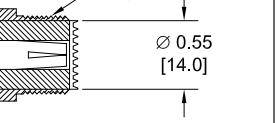
SHV	PLUG	 Ø 0.57" [14.5mm]	SMA*	MALE	 1/4-36 5/16 HEX	REVERSE POLARITY SMA	MALE	 1/4-36 5/16 HEX
	JACK	 Ø 0.44" [11.1mm]		FEMALE	 1/4-36 Ø 0.21 [5.3]		FEMALE	 1/4-36 Ø 0.21" [5.3mm]
SMA REVERSE THREAD	MALE	 1/4-36 LEFT HAND THREAD 5/16 HEX	SMB	PLUG	 Ø 0.25 [6.4]	75 OHM SMB	PLUG	 Ø 0.37 [9.2]
	FEMALE	 1/4-36 LEFT HAND THREAD Ø 0.21 [5.3]		JACK	 Ø 0.14 [3.7]		JACK	 Ø 0.24 [6.2]
SMC	PLUG	 #10-32 1/4 HEX	75 OHM SMC	PLUG	 5/16-32 11/32 HEX	SMP	MALE	 Ø 0.15" [3.7]
	JACK	 #10-32 Ø 0.14 [3.7]		JACK	 5/16-32 Ø 0.24 [6.2]		FEMALE	 Ø 0.13" [3.3]
SSMA	MALE	 #10-36 1/4 HEX	SSMB	PLUG	 Ø 0.18 [4.7]	TNC	MALE	 7/16-28 Ø 0.59 [15.0]
	FEMALE	 #10-36 Ø 0.16 [4.1]		JACK	 Ø 0.10 [2.6]		FEMALE	 7/16-28 Ø 0.38 [9.6]
75 OHM TNC	MALE	 7/16-28 Ø 0.59 [15.0]	REVERSE POLARITY TNC	MALE	 7/16-28 Ø 0.59 [15.0]	UHF	MALE	 5/8-24 Ø 0.70 [17.8]
	FEMALE	 7/16-28 Ø 0.38 [9.6]		FEMALE	 7/16-28 Ø 0.38 [9.6]		FEMALE	 5/8-24 Ø 0.55 [14.0]

*SMA, 2.92mm & 3.5mm CONNECTORS WILL MATE MECHANICALLY & ELECTRICALLY TO EACH OTHER.



Free Shipping Available
via UPS Ground to
USA & Canada



Technical
Support
(866) 727-8376



Same-Day Shipping,
Even Custom
Cable Assemblies

CONNECTOR FREQUENCY RANGE CHART

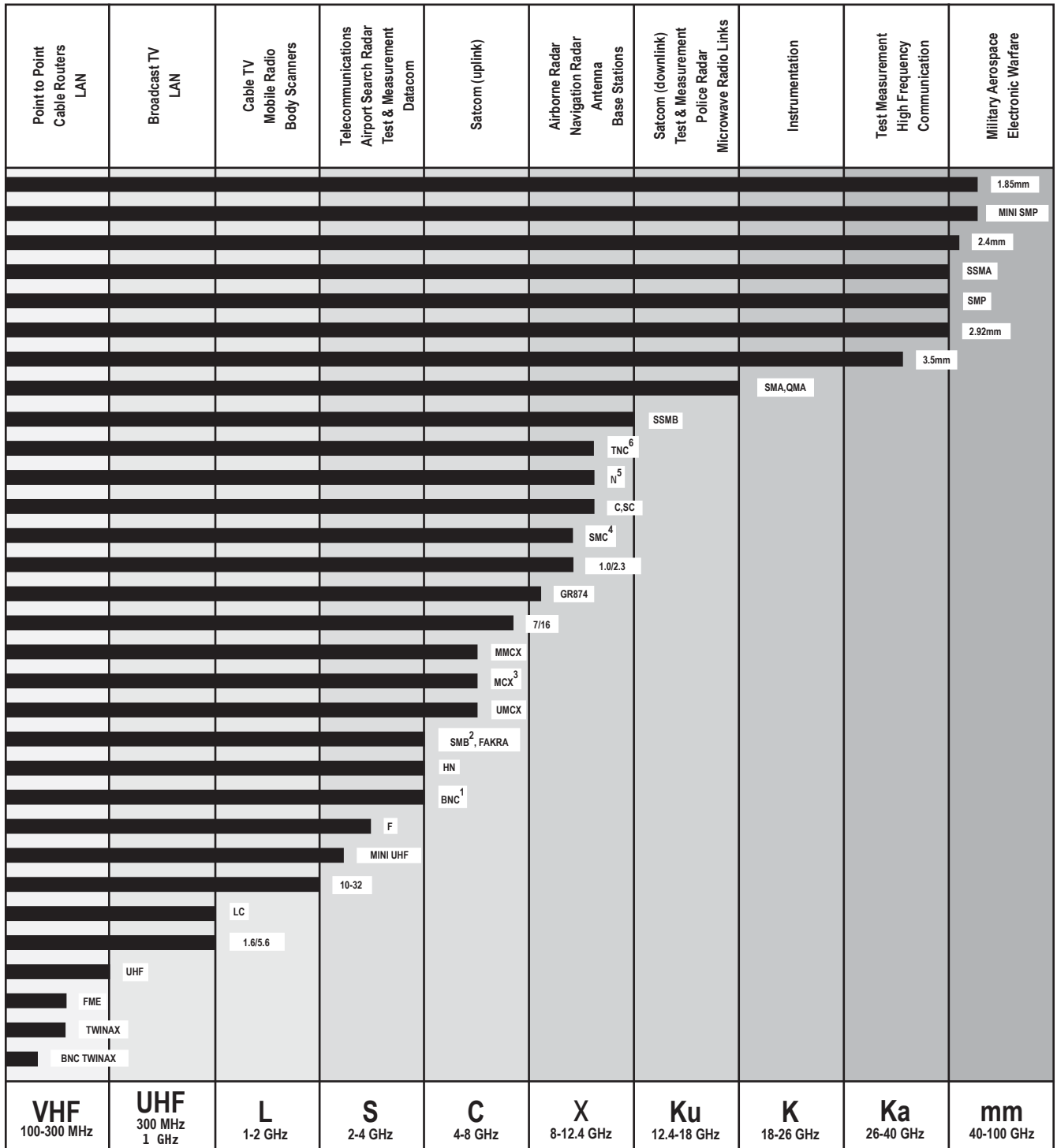

Notes:

- 1: BNC-75 Ohm connectors operate up to 1 GHz
- 2: SMB-75 Ohm & Mini SMB-75 Ohm connectors operate up to 4 GHz
- 3: MCX-75 Ohm connectors operate up to 6 GHz
- 4: SMC-75 Ohm connectors operate up to 10 GHz
- 5: N-75 Ohm connectors operate up to 1.5 GHz
- 6: TNC-75 Ohm connectors operate up to 1 GHz